

PRODUCT AND SOLUTIONS GUIDE

Connected Enterprise Solutions

EMEA



Алматы (7273)495-231
Ангарск (3955)60-70-56
Архангельск (8182)63-90-72
Астрахань (8512)99-46-04
Барнаул (3852)73-04-60
Белгород (4722)40-23-64
Благовещенск (4162)22-76-07
Брянск (4832)59-03-52
Владивосток (423)249-28-31
Владикавказ (8672)28-90-48
Владимир (4922)49-43-18
Волгоград (844)278-03-48
Вологда (8172)26-41-59
Воронеж (473)204-51-73
Екатеринбург (343)384-55-89

Иваново (4932)77-34-06
Ижевск (3412)26-03-58
Иркутск (395)279-98-46
Казань (843)206-01-48
Калининград (4012)72-03-81
Калуга (4842)92-23-67
Кемерово (3842)65-04-62
Киров (8332)68-02-04
Коломна (4966)23-41-49
Кострома (4942)77-07-48
Краснодар (861)203-40-90
Красноярск (391)204-63-61
Курск (4712)77-13-04
Курган (3522)50-90-47
Липецк (4742)52-20-81

Россия +7(495)268-04-70

Магнитогорск (3519)55-03-13
Москва (495)268-04-70
Мурманск (8152)59-64-93
Набережные Челны (8552)20-53-41
Нижний Новгород (831)429-08-12
Новокузнецк (3843)20-46-81
Ноябрьск (3496)41-32-12
Новосибирск (383)227-86-73
Омск (3812)21-46-40
Орел (4862)44-53-42
Оренбург (3532)37-68-04
Пенза (8412)22-31-16
Петрозаводск (8142)55-98-37
Псков (8112)59-10-37
Пермь (342)205-81-47

Казахстан +7(7172)727-132

Ростов-на-Дону (863)308-18-15
Рязань (4912)46-61-64
Самара (846)206-03-16
Санкт-Петербург (812)309-46-40
Саратов (845)249-38-78
Севастополь (8692)22-31-93
Саранск (8342)22-96-24
Симферополь (3652)67-13-56
Смоленск (4812)29-41-54
Сочи (862)225-72-31
Ставрополь (8652)20-65-13
Сургут (3462)77-98-35
Сыктывкар (8212)25-95-17
Тамбов (4752)50-40-97
Тверь (4822)63-31-35

Киргизия +996(312)96-26-47

Тольятти (8482)63-91-07
Томск (3822)98-41-53
Тула (4872)33-79-87
Тюмень (3452)66-21-18
Ульяновск (8422)24-23-59
Улан-Удэ (3012)59-97-51
Уфа (347)229-48-12
Хабаровск (4212)92-98-04
Чебоксары (8352)28-53-07
Челябинск (351)202-03-61
Череповец (8202)49-02-64
Чита (3022)38-34-83
Якутск (4112)23-90-97
Ярославль (4852)69-52-93

<https://molex.nt-rt.ru/> || mxd@nt-rt.ru

molex

Advanced Physical Layer Management <i>MIIM™</i>	8
Copper Solutions UTP/FTP <i>PowerCat™</i>	12
Fibre Optic Solutions <i>Lightband™</i>	42
Pre-Terminated Solutions <i>ModLink™</i>	70
Consolidation Points MMI, <i>PowerCat™</i> , <i>PowerCat™ 6</i>	76
Cable Management	80
Additional Solutions Voice, Outlet Configurations, Media Outlets <i>Contura™</i> , <i>Euromod™</i> , <i>MOD-Clip™</i> , <i>MOD-SNAP™</i> , <i>Synergy™</i> , <i>USO II™</i> , <i>MUTO</i> , <i>USP</i> , <i>WM-12</i>	84
Tools & Testers 110 Style, <i>SLT3S</i>	92



Connected Buildings Simply Solved >

From commercial centres, manufacturing, government departments to healthcare and education, your network designs will perform better and last longer with Molex technology.

As a premier provider of revolutionary new and comprehensive network technologies we offer, end-to-end structured cabling solutions including copper and fibre that connect businesses to their mission critical applications.



Transforming the way global businesses approach IT infrastructure

Partner of Choice

Molex has specialised in the design and manufacturing of high quality products that enable connected enterprises for over 30 years.

We apply the latest production techniques and have invested in sophisticated manufacturing equipment to ensure consistent high quality products and fast response to customer requirements.

With regional offices in over 10 countries including UK, Poland, America, China, UAE, Australia and India. Plus, direct trade into more than 100 countries, we have cemented our position as a world-class solutions provider.

Molex CES is part of the Molex group (a subsidiary of Koch Industries) we are globally recognised provider of electronic solutions in a wide range of industries, including data communications, consumer electronics, industrial, automotive, commercial vehicle and medical.

We have design and manufacturing facilities around the world, with an expert team of problem-solvers who work across borders to help bring your vision to life. We lead the industry in R&D investment, striving to develop and deliver innovative, high-quality, reliable solutions that can be customized to meet your needs.

Together, we can turn your vision into reality.

Why Choose Molex?

- Part of Molex, LLC with revenue of \$4 billion+ and 40,000 employees
- Certified to all the key international approvals
- Product Lifetime guarantee
- Trust, integrity & support
- Localised customer service worldwide

Connected Buildings Simply Solved >



Ecocare

As a responsible corporate citizen, we are committed to using environmentally conscious practices during the design and manufacture of our products. These environmental practices are designed to ensure that Molex is developing sustainability through environmental preservation activities.



Comply with all relevant environmental, health and safety compliance obligations

Operate our facilities in a way that considers the efficient use of natural resources and provides a safe and healthy workplace. Develop products that minimize environmental impact



Continually improve our environmental, health and safety performance and operations

Advise Molex employees and business partners of the importance of adhering to this Policy

Reduce or eliminate emissions and discharges through pollution prevention activities: Prevent injury and illness through management practices

Educate employees to work in an environmentally responsible and safe manner

Molex Accreditation

Our worldwide manufacturing sites are certified to the ISO 14001 environmental management system standard, which requires that a broad range of environmental processes and policies be in place to minimize environmental impact and maintain compliance with environmental regulations.

Product Lifetime Guarantee

We're proud of our own manufacturing standards, as well as the quality of work provided by our global Certified Installer network. So proud in fact, that our structured cabling products enjoys a 25-year System Performance and Application Assurance Warranty. It's simple and fuss-free, providing you with the confidence, technical excellence and long-term financial security you demand for your business.





Training Courses

Your organisational needs continuously evolve, and your Molex CES products and services help you keep pace with operational demands. Our growing training portfolio can help optimise your team's proficiency. Increase the return on your investment with our versatile training solutions and best practices from our expert instructors and designers.

Software Tools

Three essential software tools for system consultants and advisers.

- Cable Fill Rate estimator, used to calculate different widths and types of cable and how many you will be able to fit in cable pathways
- Consultant Proposal Generator
- BoM Estimator

Data Centres

Data centres are a critical resource for many businesses, as reliance on digitally stored information grows. Molex Structured Cabling delivers:

- The performance, reliability and uptime data centres demand
- Consistent quality, from design and procurement through deployment and routine moves, adds and changes

Manufacturing & Industrial

Harsh conditions can complicate IT infrastructure in manufacturing and industrial settings. Molex Structured Cabling:

- Certified for reliability and durability
- Offers incremental savings with minimal risk
- Broad product range to meet the diverse needs of our customers while maintaining a focus on robust and reliable solution

Education

Education is going digital and global, with webinars, video conferencing and on-demand content. Molex Structured Cabling helps:

- High-traffic networking with reliable uptimes
- Top quality at a cost-effective price

Healthcare

The growing volumes of patient records, imaging and video consultations must be delivered quickly and securely throughout the growing healthcare ecosystem. Molex Structured Cabling helps:

- Enable and leverage the Internet of Things
- Protect their investment, with a cost-effective approach that's backed by a 25-year warranty



Your physical layer infrastructure Simply Solved >



With the rapid growth of IP-based systems, cloud services and the Internet of Things, it has become essential to ensure that the LAN cabling system you specify and install today, meets the needs of your organisation tomorrow.



Advanced Physical Layer Management



MIIM G3

The MIIM solution enables complete real-time monitoring of the physical channel between MIIM panels, while supporting easy communication to SNMP based network management tools. MIIM's Device Discovery Toolkit, including Global, Directed and Event-Driven Discovery populate the MAC and IP addresses of discovered devices to the MIIM database, enabling continuous monitoring & mapping the physical layer.

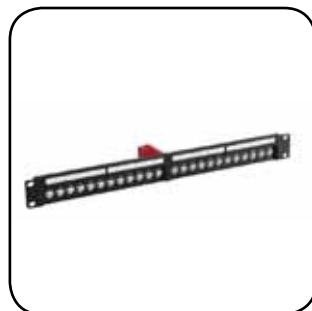

It facilitates work order management, including scheduling and recording of moves, adds and changes (MACs), and enables patch guidance for technicians, with LEDs on the patch panels to indicate ports with pending work orders.

Advanced Physical Layer Management

MIIM™



MIIM Scanner

MIIM scanners monitor activity on a MIIM enabled system. Each 1U scanner can be connected to up to 48 patch panels, providing monitoring of up to 1152 separate physical channels. Standard RJ45 patch cords are used as the data bus connection between scanners and patch panels.

MIIM scanners can be configured and activated independently of the software. When the MIIM application software is connected to the scanner, it "discovers" active hardware and devices on the network and uploads this information onto the MIIM application software. Scanners monitor the connection state of MIIM channels and pass state change data to the MIIM application software. This triggers MIIM's Event-Driven Discovery function which queries the associate switch and updates the software.

- Event-Driven Discovery enables continuous updating of MIIM with minimal impact to the network
- Simple scanner configuration
- Mission critical port disconnection alerts
- Low power consumption with no fans or cooling required
- Transaction queues record events for later delivery if the scanner is disconnected from the MIIM application
- Data bus connection between the scanner and patch panel is via an industry standard RJ45 patch cord



PowerCat Patch cords Page 23

Order No.	SAP No.	Description
IMS-00100	183240000	MIIM 576 Channel Scanner
IMS-00101	183240008	MIIM 96 Channel Scanner



MIIM G3 Patch Panels

MIIM G3 Patch Panels are used within the MIIM System. Each 1U 24 Port Patch Panel has one data bus connection port located on the rear of the panel which is used to connect the control unit. The control unit connects the panel to the MIIM scanner via a standard RJ45 patch cord.

The patch panel is used by the MIIM system to track connectivity in the patch zone. LED status indicators on the control unit show status of connectivity between the panel and the scanner and also the LED indicators on the panel provide panel guidance for work orders. Each panel contains 24 MIIM jacks which can be removed from the panel to be terminated individually with standard punch down tools. MIIM panels function as a standard patch panel when not connected to the MIIM system.

- 24 Ports 1U
- Cat 6 UTP and Cat 6A FTP
- EIA 568A/B wired
- Standard 19" rack mount
- Data bus connection to the MIIM G3 control unit
- Integral cable management shelf ensures bend radius compliance
- International hardware kit contains both ANSI and metric hardware
- Can be terminated using industry standard punch-down tools
- RoHS Compliant
- Intelligent Control unit need to be purchased separately



Solid Cable Assemblies Page 22

Order No.	SAP No.	Description
PID-00283	183200023	1U 24 Port Category 6 UTP MIIM G3 Jack Loaded Patch Panel W/O Control Unit
PID-00285	183210036	1U 24 Port Category 6A Shielded MIIM G3 Jack Loaded Patch Panel W/O Control Unit



MIIM G3 Intelligent Control Unit

The MIIM G3 intelligent control unit enables MIIM Ready G3 panels to sense adds, moves, and changes across all 24 ports on the panel. The control unit contains LED's to indicator the power supply from scanner. Control unit can be easily added to MIIM ready panels to activate full MIIM capabilities. The control unit contains an RJ45 jack to connect it to the MIIM scanner via a standard patch cord. MIIM Panels with control units that are not connected to a MIIM scanner function the same as a standard patch panel.

- MIIM Control unit provides intelligent management for MIIM G3 panels
- MIIM Control unit is easily added and removed from any MIIM G3 panel
- MIIM Control unit can be mounted on the panel by embedded screw
- MIIM Control unit is powered by the scanner
- Two power status indicators to ensure proper connection of power supply from the scanner
- Control units for fibre & copper panels are different

Order No.	SAP No.	Description
IMD-00005	183240015	MIIM G3 Intelligent control unit for copper panel - Red
IMD-00006	183240016	MIIM G3 Intelligent control unit for fibre panel - Yellow

Advanced Physical Layer Management

MIIM™



MIIM G3 24 Port Duplex LC Fibre Panel

MIIM™ G3 Fibre Optic panels are used within the MIIM System. The adapter interface is 24 duplex LC adapters. Each 1U 24 Port enclosure has one data bus connection port located on the rear of the panel that connects the panel to a MIIM Intelligent control unit. When connected to a MIIM scanner via control unit, the panels detect connection activity on each duplex LC port. The patch panel works as a conventional patch panel when not connected to the MIIM system

- 1U 24 port/48 fibre in LC duplex adapter
- Data bus connection to the MIIM G3 control unit
- Panel options for singlemode and multimode
- Slide out cable management shelf
- Recessed mounting provides adequate space for routing patch cords, even in free standing enclosures with the front door closed
- ANSI and international metric hardware kit provided
- Intelligent Control unit need to be purchased separately
- Using standard LC duplex fibre patch cord to connect MIIM G3 fibre panels

Order No.	SAP No.	Description
RFR-00318	183230013	MIIM G3 48F Duplex LC MM Fibre Patch Panel, W/O control unit
RFR-00319	183230014	MIIM G3 48F Duplex LC SM Fibre Patch Panel, W/O control unit

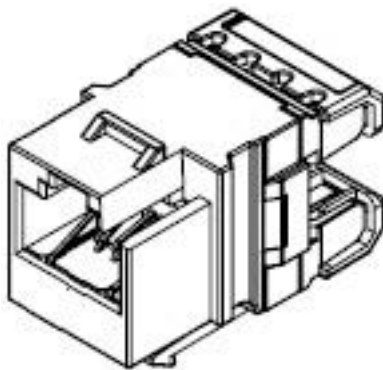

MIIM G3 Keystone Jack Category 6 UTP

The MIIM G3 C6 UTP Keystone Jack is in addition to the MIIM G3 product line designed for installation in MIIM G3 Keystone size apertures for panel installations. The jack can be terminated using industry standard punch-down tools.

The jack is designed for use in a standard permanent link or channel configuration so the standard Molex C6 UTP DataGate jack are installed in the Telecommunication/Wall Outlets.

- Dual colour-coding allows for 568 A/B wiring configuration patch panel and the work area outlet
- Exceeding Category 6 performance providing full support to Gigabit Ethernet
- Compatible with 22-24 AWG solid conductors providing support to wider range of cabling types
- Can be terminated using industry standard punch down tools
- Molded category identification on jack face

Order No.	SAP No.	Description
KSJ-00089	180430046	Category 6, G3 UTP MIIM, Keystone Jack - white



MIIM Application Software

MIIM Application Software is a client server based Software program and is the central data manager for the MIIM System. It manages OSI Layer 1 assets and provides instantaneous information to the IT Manager regarding connectivity on MIIM enabled channels. The software documents planned and unplanned changes to the network. It allows continuous monitoring of the physical channel between MIIM panels. It automatically monitors all connections/disconnections, updates all MACs to the database, identifies and confirms port availability and notifies the IT Manager of all unscheduled or unauthorized network changes. Event-Driven Discovery gathers device information attached to outlets and is triggered by updates to the scanner. The software allows global network access and cost-effective network management.

- Hierarchal view of entire enterprise layer 1 infrastructure to the port/outlet
- Event monitoring of all connections/disconnections
- Event-Driven Discovery keeps data current and minimises network bandwidth usage
- Enables guided patching
- Search feature to easily locate assets and information
- Event logs for audit trails
- Layer 1 assets linked to building maps
- Open systems architecture can link with other network management applications
- Suite of management reports available
- Unrestricted number of users per license

Order No.	SAP No.	Description
IMA-00102	183250004	MIIM Server Application License
IMM-00102	183250005	MIIM Server Support/Maintenance
IMA-00101	183250003	MIIM 96 Channel License
IMM-00101	183250002	MIIM 96 Channel License Software Maintenance

Reliable product performance Simply Solved >

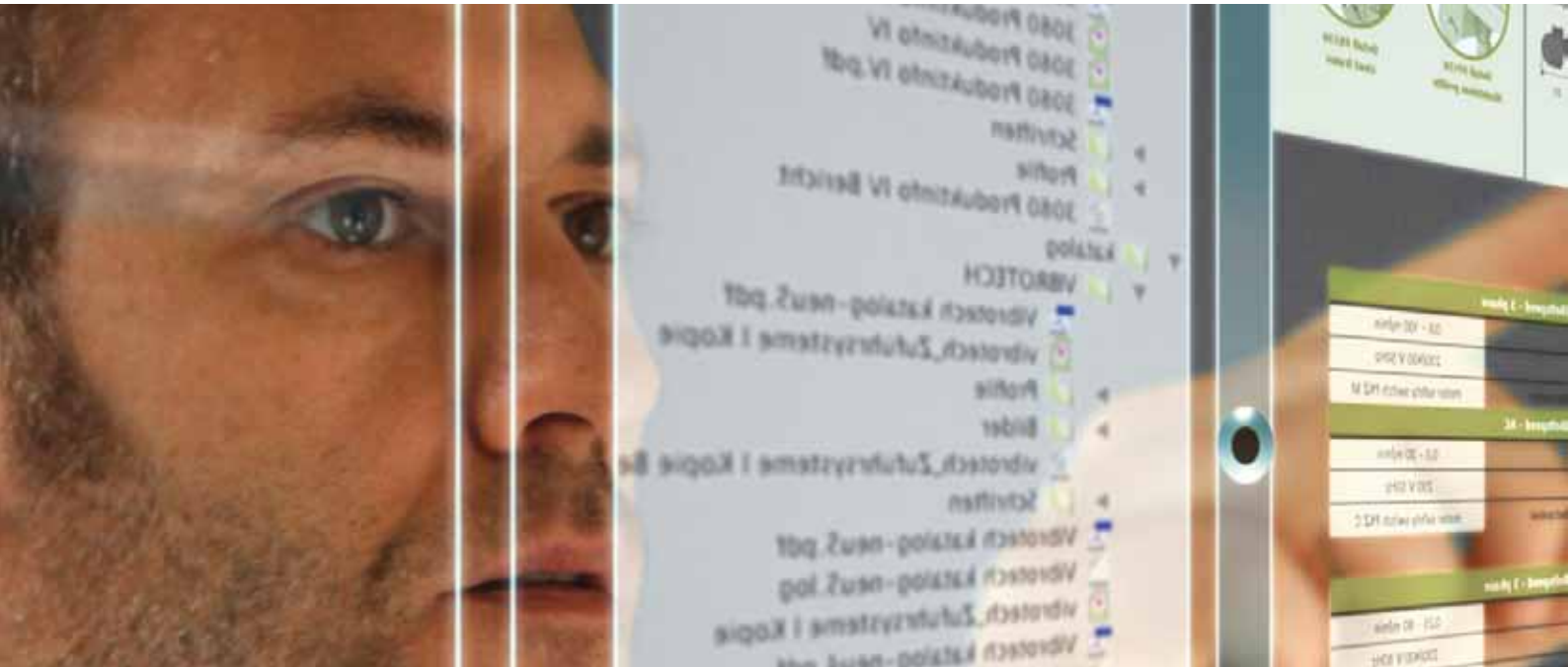

Copper based Ethernet technology evolves and improves, providing continued adoption with enterprises. Technical advances have enabled the higher density, reduced power and improved cost-effectiveness.

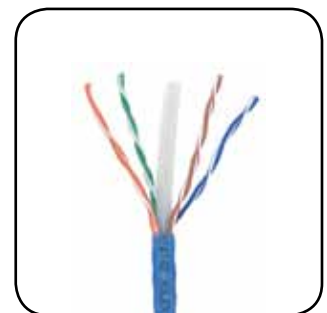



Copper Solutions

PowerCat 5e

Molex's Category 5e product range is known as the PowerCat system and is designed to meet or exceed the requirements of current international standards. The product range offers backwards compatibility with Category 5 systems, with enhanced performance.

PowerCat 6

Molex's Category 6 Product Range, PowerCat 6, is designed to meet or exceed the requirements of current international standards and has been independently tested and verified by ETL SEMKO for Category 6 component compliance. The solution features cable, patch cords, patch panels and wall outlet solutions suitable for a wide range of territorial requirements.

PowerCat 6A Shielded

Designed to support 10-Gigabit Ethernet (10GBase -T), Category 6A is an optimum speed structured cabling solution offering superior performance where speed, reliability, future proofing or long term tenancy is required. It is the system of choice for Data Centres, financial institutions and enterprises requiring the maximum performance level for their businesses. The PowerCat 6A shielded solution is designed specifically for high speed data transmissions demanding little room for error, whilst offering exceptional alien crosstalk suppression, excellent insertion loss protection and protection against Electromagnetic Interference (EMI).

PowerCat 6A Unshielded

Molex PowerCat™ 6A solution has been developed with the highest performing capabilities in mind. With improved data transmission over higher frequencies and enhanced noise suppression. Our solution has been designed to provide alien crosstalk mitigation and is verified to ANSI/TIA 568C.2 and ISO 11801 Category 6A standards.

The key components of the system are the PowerCat 6A UTP Keystone Jack with an optional shutter, the Molex C6A unshielded cable offers one of the lowest overall cable diameters in the industry allowing higher cable density and reducing cost. The complete end-to-end solution also includes a range of modular patch panels and wall outlets.

Copper Solutions PowerCat™ 6A UTP



PowerCat 6A Unshielded LS0H Cable

The PowerCat 6A Unshielded LS0H Cable is specifically designed to support high speed data network applications such as 10GBASE-T. The innovative design features an isolation foil wrap for alien crosstalk defence and offers a low nominal diameter allowing for a higher cable density and a lower bend radius. The product is 3rd party verified to ANSI/TIA-568.2-D and ISO 11801 Cat 6A standards.

- Suitable for any high-speed data application up to 500MHz 10/100/10GBASE-T
- Backward compatible to legacy protocols and applications
- IEEE 802.3bt Type 1,2,3 and 4
- ANSI/TIA-568.2-D and ISO 11801 Cat 6A standard verified
- No grounding or bonding required
- Low overall cable diameter offers high cable density and low bend radius, reducing the installation cost

Order No.	SAP No.	Description
CAA-00424-BL	1810000014	PowerCat 6A Unshielded Dca-s2,d2,a1 Cable Blue 500m reel



PowerCat 6A UTP Keystone Jack

Designed to comply with the transmission performance of ANSI/TIA-568-C.2 Augmented Category 6. The Keystone Jack design is a popular, universal dimension that fits into a wide range of wall outlet and enclosure products. The PowerCat 6A UTP jack includes a snap-on shutter to protect against dust ingress. The product is designed to achieve the high level of functionality required for high-speed 10 Gbps data transmission. The product is also backward compatible with Category 6 and 5e systems. The Category 6A UTP Keystone Jack is 3rd party tested and verified for transmission performance, safety and 4PPoE+ compliance.

- Popular keystone design
- Optional shutter for dust protection
- 568A or 568B wiring option
- Rear metal-wrapped cable retention cap provides greater alien crosstalk protection
- 3rd party verified

Order No.	SAP No.	Description
KSJ-00091-**	Consult Molex	Keystone Jack C6A UTP 568A/B

** Colour Options - 02 = White, 04 = Black, RD = Red, BL = Blue, 08 = Grey, 05 = Ivory
Standard Stocked Colours - Black and White. All colours may be subject to availability and variable pricing.



Keystone Patch Panel

The Molex 24 Port Modular Keystone Patch Panel is a flexible patching solution for small to medium size installations. The panel is shipped unloaded and can be configured to provide the exact number of ports required. The Keystone Jacks snap in easily and can be removed if required.

The patch panel features an integral rear cable management tray for ease of installation and cable dressing. Port identification can be provided by utilising the silk screened areas shown on the front of the panel.

- Available in 24 Ports 1U
- Modularity provides installation flexibility
- Easy snap in Keystone Jacks
- Rear cable management included
- Graphite grey finish
- Accepts UTP Keystone Jacks only

Order No.	SAP No.	Description
PID-00257	0180810023	24 Port Keystone Patch Panel - Unloaded - 1U

Copper Solutions PowerCat™ 6A UTP



PowerCat 6A Patch Cords

Molex PowerCat 6A Shielded Patch Cords are key components of the PowerCat 6A shielded end-to-end solution. Designed to support high speed 10GBASE-T networks, they are also backward compatible with 10/100/1000BASE-T networks. The patch cable is made from high quality four pair 26 AWG stranded copper wire. The patch cords are pre-terminated with RJ45 plugs and feature anti-slug slim strain relief slip on boots.

- 4 pair 26 AWG shielded stranded copper cable
- Pre-terminated with RJ45 plugs
- Slim clear anti-slug slip on boots
- Suitable for EIA 568A/B wiring applications
- LS0H jacket
- 10G Performance when installed as a complete PowerCat 6A Shielded System
- RoHS Compliant
- Available in a range of colours and lengths

Order No.	SAP No.	Description
PCD-07000.**	Consult Molex	PowerCat 6A Patch Cord 568A/B Shielded, LS0H - 1m
PCD-07061.**	Consult Molex	PowerCat 6A Patch Cord 568A/B Shielded, LS0H - 1.5m
PCD-07001.**	Consult Molex	PowerCat 6A Patch Cord 568A/B Shielded, LS0H - 2m
PCD-07002.**	Consult Molex	PowerCat 6A Patch Cord 568A/B Shielded, LS0H - 3m
PCD-07004.**	Consult Molex	PowerCat 6A Patch Cord 568A/B Shielded, LS0H - 5m
PCD-07006.**	Consult Molex	PowerCat 6A Patch Cord 568A/B Shielded, LS0H - 7m
PCD-07009.**	Consult Molex	PowerCat 6A Patch Cord 568A/B Shielded, LS0H - 10m

** Colour Options - 0C = Red, 0E = Grey, 0H = Blue, 0J = Green, 0K = Yellow, 0W = White, 0P = Purple, 0N = Orange, BK = Black
Standard Stocked Colours - Grey, Red, Blue. All colours and lengths may be subject to availability and variable pricing.

Copper Solutions

PowerCat™ 6A Shielded



PowerCat 6A U/FTP Cable

- Supports high speed data network applications such as 10-Gigabit Ethernet (10GBASE-T)
- Enhanced performance individually screened 4 pair U/FTP LS0H cable
- Minimises alien crosstalk, provides excellent signal isolation and provides superior electromagnetic interference (EMI) protection.
- ETL verified to TIA/EIA-568-B.2-10 Category 6A standard
- Resistant to alien crosstalk
- Colour coded for ease of termination
- 500m Reel
- Compliant with EN 50575:2014+A1:2016 EU Reaction to Fire Performance criteria

Order No.	SAP No.	Description
CAA-0322L-VL	183020029	PowerCat 6A U/FTP LS0H Cable Dca-s2,d1,a1 Violet - 500m
CAA-0334-VL	183020023	PowerCat 6A U/FTP LS0H Cable Cca-s1a,d1,a1 Violet - 500m
CAA-0413-VL	183020040	PowerCat 6A U/FTP LS0H Cable B2ca-s1a,d1,a1 Violet 500m



Category 7 S/FTP Cable

Category 7 S/FTP Cable (each pair has individual shield plus a common shield for the cable made of tinned copper braid) is a complementary product for shielded PowerCat 6 and PowerCat 6A (with limitations) systems.

The cable is suitable for horizontal cabling in high speed data transmission networks as well as vertical cabling for data. Small outer diameter, high flexibility and superior electrical performance are key features of the product.

- Transmission performance C7 in a 1-600MHz range as per IEC 61156-5
- Provides significant margins for NEXT, Power Sum NEXT, PowerSum ELFEXT
- Alien NEXT is significantly reduced so it can be used for 10G Application
- Small outer diameter, high flexibility
- 1000m lengths on wooden, fully recyclable reels
- Compliant with EN 50575:2014+A1:2016 EU Reaction to Fire Performance criteria

Order No.	SAP No.	Description
CAA-00358	183530002	Category 7 S/FTP LS0H Cable Dca-s1a,d1,a1 Violet - 1000m
CAA-00360	183530002	Category 7A S/FTP LS0H Cable Dca-s1a,d1,a1 Violet - 500m reel



PowerCat 6A DataGate™ Shielded Jack

The DataGate Jack is the cornerstone of the Molex PowerCat 6A System performance. The product offers superior alien crosstalk suppression, excellent insertion loss protection and enhanced electromagnetic interference (EMI) protection. Protection is provided by utilising a robust die-cast zinc alloy connector body housing.

This shielded jack features a unique spring-loaded shutter that not only protects it from dust and contaminants, but the ingenious spring-loaded design also ejects improperly seated patch cords. The product is dual colour coded for either 568A or 568B wiring schedules and is backwards compatible with Shielded C6 and C5e systems. Also available in side entry variation, ideal for use in work area outlet applications with limited back box space.

- 360° Shielded RJ45 Jack
- Robust die-cast zinc alloy housing
- Dual Colour coding allows 568A/B wiring
- Patented IDC V-Shaped contacts that flex not fatigue when terminated
- Patented spring-loaded shutter
- RJ-11 compatible
- Accepts colour coded port identification labels
- Supplied with all C6A patch panels and wall outlets
- Available in either traditional rear or side entry variations
- Side entry jack allows cable termination either side
- 100% factory tested
- RoHS compliant
- Molex 4 Pair Termination Tool or industry standard 110 termination tool compatible

DataGate Shutter Operation

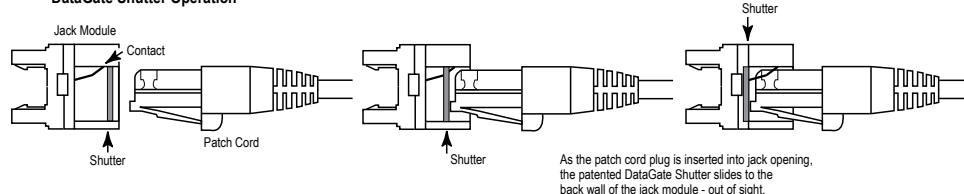

Order No.	SAP No.	Description
KSJ-00062-**	Consult Molex	PowerCat 6A Jack RJ45 568A/B Shielded
KSJ-00073-**	Consult Molex	PowerCat 6A Side Entry Jack Shielded

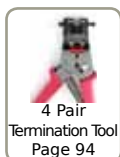

Copper Solutions

PowerCat™ 6A Shielded



PowerCat 6A Shielded Patch Panels

PowerCat 6A Patch Panels features the unique DataGate shielded connector. This shielded connector offers superior alien crosstalk suppression, excellent insertion loss protection and provides enhanced electromagnetic interference (EMI) protection by utilising robust die-cast zinc alloy connector body housing.

Patch Panels are made from robust sheet metal and are supplied with removable rear cable management trays for cable strain relief and neat cable dressing, front and rear port numbering and individual ports may be colour coded using connector icon labels for site specific network administration.

- 24 Ports 1U & 48 Port 2U
- EIA 568A/B wired
- ETL Verified
- Standard 19" rack mount
- IDC contacts that flex not fatigue when terminated
- Pointed IDC towers to speed termination and enhance cable retention
- Integral cable management shelf ensure bend radius compliance
- Grounding screws included

Order No.	SAP No.	Description
PID-00217	0182960000	PowerCat 6A 24 Port Patch Panel 568A/B Shielded - 1U
PID-00219	0182960002	PowerCat 6A 48 Port Patch Panel 568A/B Shielded - 2U
PID-00218	182960001	PowerCat 6A 24 Port Angled Patch Panel 568A/B Shielded - 1U
PID-00220	182960003	PowerCat 6A 48 Port Angled Patch Panel 568A/B Shielded - 2U
Accessories		
CSP-00021-**	Consult Molex	Blank Connector Icon Labels 6-Pack (Bag of 10)

** Colour Options - 01 = Almond, 02 = White, 04 = Black, 05 = Ivory, 08 = Light Grey, RD = Red, BL = Blue, GR = Green, YL = Yellow, RG = Orange, PP = Purple. All colours may be subject to availability and variable pricing.



PowerCat Unloaded DataGate Panels

The Molex PowerCat Unloaded DataGate Patch Panels can be configured to provide the exact number of modular ports required. DataGate Category 5e UTP, Category 6 UTP, or Category 6A shielded jacks can be terminated to cable and then snapped into this DataGate patch panel. The patch panel and rear cable manager are constructed of cold-rolled steel for strength and durability.

- Available in 1U 24P Flat, 1U 24P Angled, 2U 48P Flat, 2U 48P Angled
- Easy snap in DataGate UTP or Shielded Jacks (sold separately)
- Modularity provides installation flexibility
- Front portable labelling
- Individually removable patch panel ports
- Removable cable management shelf ensures bend radius compliance
- ANSI and metric hardware kit included
- Grounding screws included



Order No.	SAP No.	Description
PID-00258	180810031	PowerCat 24 Port DataGate Patch Panel, Unloaded UTP or Shielded - 1U
PID-00259	180810032	PowerCat 24 Port DataGate Angled Patch Panel, Unloaded UTP or Shielded - 1U
PID-00260	180810033	PowerCat 48 Port DataGate Patch Panel, Unloaded UTP or Shielded - 2U
PID-00261	180810034	PowerCat 48 Port DataGate Angled Patch Panel, Unloaded UTP or Shielded - 2U
KSJ-00005-0*	Consult Molex	Single Position Blank Module (Bag of 25)

* Colour Options - 2 = White, 4 = Black



PowerCat 6A Unloaded DataGate Adapter Plate

The Unloaded Adapter Plate 3 x C6A DataGate Jacks is designed for applications where fibre and copper are required in a single panel. The Adapter Plate is designed to accept the DataGate Category 6A Jack (part number KSJ-00062-0*) and snap fits into the Multi-Functional or Specification Grade Fibre Optic Panels. The Adapter Plate can also be combined with Fibre Optic 6 Fibre Adapter Plates for multi-media applications.

- Accommodates 3 x PowerCat 6A DataGate Jacks
- For use within Molex Multi-Functional or Specification Grade Fibre Panels
- Allows multi-media flexibility within a single enclosure/panel



Order No.	SAP No.	Description
AFR-00441	183190030	Adapter Plate 3x PowerCat 6A DataGate (with grounding screws) unloaded

Copper Solutions PowerCat™ 6A Shielded



PowerCat 6A Contura™ Module

The PowerCat 6A Contura Module was designed to combine aesthetics with functionality. The contemporary design of the product is ideal for the modern office and provides the user with the flexibility of modularity. Compatible with Contura wallplates, the module is supplied with a protected label facility and the angled design reduces patch cord bend radius. This product is shipped complete with the shielded C6A DataGate™ jack. Individual ports may be colour coded for site-specific network administration by fitting connector icon labels (part no. CSP-00021-0**).

- Contemporary design
- Protected labelling facility
- 50 x 22mm fascia
- Compatible with Contura wallplates
- Supplied with DataGate C6A jack



Order No.	SAP No.	Description
MGB-00006-02	0183010004	PowerCat 6A Angled Contura RJ45 Module, 568A/B Shielded - White



PowerCat 6A Consolidation Point Enclosure MUTO

Consolidation Points or Multi-User Telecommunications Outlets (MUTO) are intended to provide increased flexibility and economy for installations where open office spaces require frequent re-configuration.

- Allows moves, adds and changes without re-terminating and re-testing of cable
- 8 port capacity
- Rugged enclosure
- Factory assembled
- PowerCat 6A Shielded DataGate Modules included
- RoHS compliant

Order No.	SAP No.	Description
CPT-00053	0180080078	PowerCat 6A 8 Port Consolidation Point Enclosure, Shielded



PowerCat 6A Patch Cords

Molex PowerCat 6A Shielded Patch Cords are key components of the PowerCat 6A shielded end-to-end solution. Designed to support high speed 10GBASE-T networks, they are also backward compatible with 10/100/1000BASE-T networks. The patch cable is made from high quality four pair 26 AWG stranded copper wire. The patch cords are pre-terminated with RJ45 plugs and feature anti-slag slim strain relief slip on boots.

- 4 pair 26 AWG shielded stranded copper cable
- Pre-terminated with RJ45 plugs
- Slim clear anti-slag slip on boots
- Suitable for EIA 568A/B wiring applications
- LS0H jacket
- 10G Performance when installed as a complete PowerCat 6A Shielded System
- RoHS Compliant
- Available in a range of colours and lengths

Order No.	SAP No.	Description
PCD-07000-**	Consult Molex	PowerCat 6A Patch Cord 568A/B Shielded, LS0H - 1m
PCD-07061-**	Consult Molex	PowerCat 6A Patch Cord 568A/B Shielded, LS0H - 1.5m
PCD-07001-**	Consult Molex	PowerCat 6A Patch Cord 568A/B Shielded, LS0H - 2m
PCD-07002-**	Consult Molex	PowerCat 6A Patch Cord 568A/B Shielded, LS0H - 3m
PCD-07004-**	Consult Molex	PowerCat 6A Patch Cord 568A/B Shielded, LS0H - 5m
PCD-07006-**	Consult Molex	PowerCat 6A Patch Cord 568A/B Shielded, LS0H - 7m
PCD-07009-**	Consult Molex	PowerCat 6A Patch Cord 568A/B Shielded, LS0H - 10m

** Colour Options - 0C = Red, 0E = Grey, 0H = Blue, 0J = Green, 0K = Yellow, 0W = White, 0P = Purple, 0N = Orange, BK = Black
Standard Stocked Colours - Grey, Red, Blue. All colours and lengths may be subject to availability and variable pricing.

Copper Solutions PowerCat™ 6A Shielded



PowerCat 6A Solid Cable Assemblies

Molex PowerCat 6A shielded solid cable assemblies are ideal for consolidation point cabling or as equipment cords within a PowerCat 6A shielded end-to-end solution. The PowerCat 6A shielded solution is specifically designed to support secure-high speed 10GBASE-T networks and is backward compatible with 10/100/1000BASE-T networks. Cable assemblies are made from high quality shielded four pair 23 AWG solid copper wire and are pre-terminated with RJ45 plugs and feature anti-snag slip on boots.

- 4 pair 23 AWG solid copper wire
- Pre-terminated with RJ45 shielded plugs
- Anti-snag slip on boots
- TIA/EIA-568B wiring
- LS0H sheath
- 10G Performance when installed as a complete PowerCat 6A Shielded System
- RoHS Compliant
- Cable - Compliant with EN 50575:2014+A1:2016 EU Reaction to Fire Performance criteria

Order No.	SAP No.	Description
PCD-07054-VL	183160844	PowerCat 6A Shielded Solid Cable Assembly, U/FTP, LS0H, VL Dca-s2,d1,a1 4m
PCD-07055-VL	183160845	PowerCat 6A Shielded Solid Cable Assembly, U/FTP, LS0H, VL Dca-s2,d1,a1 6m
PCD-07056-VL	183160846	PowerCat 6A Shielded Solid Cable Assembly, U/FTP, LS0H, VL Dca-s2,d1,a1 8m
PCD-07057-VL	183160847	PowerCat 6A Shielded Solid Cable Assembly, LS0H, U/FTP, VL Dca-s2,d1,a1 10m
PCD-08000-OP	183270077	PowerCat 6A Shielded Solid Cable Assembly, LS0H, U/FTP, VL Dca-s2,d1,a1 15m
PCD-07058-VL	183160848	PowerCat 6A Shielded Solid Cable Assembly, LS0H, U/FTP, VL Dca-s2,d1,a1 20m
PCD-08001-OP	183270078	PowerCat 6A Shielded Solid Cable Assembly, LS0H, U/FTP, VL Dca-s2,d1,a1 25m
PCD-07059-VL	183160849	PowerCat 6A Shielded Solid Cable Assembly, LS0H, U/FTP, VL Dca-s2,d1,a1 30m
PCD-08002-OP	183270079	PowerCat 6A Shielded Solid Cable Assembly, LS0H, U/FTP, VL Dca-s2,d1,a1 35m
PCD-07060-VL	183160850	PowerCat 6A Shielded Solid Cable Assembly, LS0H, U/FTP, VL Dca-s2,d1,a1 40m
PCD-08003-OP	183270080	PowerCat 6A Shielded Solid Cable Assembly, LS0H, U/FTP, VL Dca-s2,d1,a1 50m
PCD-08004-OP	183270081	PowerCat 6A Shielded Solid Cable Assembly, LS0H, U/FTP, VL Dca-s2,d1,a1 60m



Locking patch cord RJ45-RJ45, 568B, F/FTP, Stranded, PowerCat 6A, LS0H, Grey

Molex Premise Networks Locking Patch Cords complement the PowerCat 6A shielded end-to-end solution. Molex PowerCat 6A Patch Cords are designed to support high speed networks including 10GBASE-T and 1000BASE-T. The Patch cables are equipped with RJ45 connectors protected by a locking mechanism. Once the patch cord is connected, it cannot be removed without the use of the specially designed key. This solution prevents unauthorized changes in patch cable connections within the Telecommunication Outlet zone or Patching zone. It also allows for the protection of strategic connections within the system. The patch cable is

made from high quality four pair F/FTP shielded 26 AWG stranded copper wire available in grey only. Six standard lengths are offered: 1m, 2m, 3m, 5m, 7m and 10m.

Keys for Locking Patch Cords are available in packs of 5 pieces.

- Patch cords are equipped with RJ45 connectors protected by a lock
- 4-Pair 26AWG shielded F/FTP cord with LS0H outer sheath
- Slim clear anti-snag slip on boots
- 568B wiring
- LS0H Sheath
- RoHS Compliant

Order No.	Description
PCD-07069-0E	Locking Patch cord RJ45-RJ45, 568B, F/FTP, Stranded, PowerCat 6A, LS0H 1m Grey
PCD-07071-0E	Locking Patch cord RJ45-RJ45, 568B, F/FTP, Stranded, PowerCat 6A, LS0H 2m Grey
PCD-07073-0E	Locking Patch cord RJ45-RJ45, 568B, F/FTP, Stranded, PowerCat 6A, LS0H 3m Grey
PCD-07077-0E	Locking Patch cord RJ45-RJ45, 568B, F/FTP, Stranded, PowerCat 6A, LS0H 5m Grey
PCD-07079-0E	Locking Patch cord RJ45-RJ45, 568B, F/FTP, Stranded, PowerCat 6A, LS0H 7m Grey
PCD-07082-0E	Locking Patch cord RJ45-RJ45, 568B, F/FTP, Stranded, PowerCat 6A, LS0H 10m Grey
PCD-07083	Pack of 5 Keys for Locking Patch Cords

Copper Solutions PowerCat™ 6A Shielded



PowerCat 6A Field Termination Plug

Molex's Category 6A field terminable plug is designed to support 10 Gigabit networks and can be easily terminated using parallel jaw pliers. Termination is accomplished by placing the conductors into the proper wire slots in the wire cap. Placing the wire cap onto the plug, using pliers to squeeze the wiring cap. All eight conductors are simultaneously terminated when the wire cap is squeezed. This process ensures quick, consistent, reliable terminations.

- Ideal for use to provide high-bandwidth wireless access points and other IP-enabled devices such as: Surveillance cameras and infrastructure monitoring
- Ideal in data centres, premise network applications and premise automation
- Accommodates diameter conductors from 22-26 AWG solid wire
- Meets TIA-568-C.2 Category 6A component performance, Cat 5e/6 and 6A Direct Attach link and channels

Order No.	SAP No.	Description
KSP-00001	Consult Molex	Category 6A Field Termination Plug

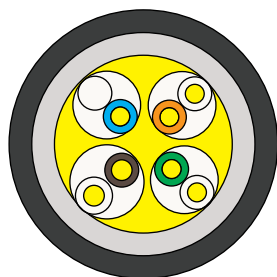

Category 6A U/FTP Gel-Filled Outdoor Cable Nylon Sheath

The Molex outside plant gel-filled Category 6A 4 Pair U/FTP cable utilises a HDPE compound which insulates the cores while a PE (UV) sheath provides protection against moisture and UV. An additional nylon outer jacket provides protection against abrasion and termites. The rugged construction of this cable makes it ideal for outdoor/underground installations.

- Category 6A compliant
- PE (UV) and nylon sheathed for greater protection
- UV resistant
- Suitable for outdoor/underground installations
- Water resistant gel-filled design
- Compliant with EN 50575:2014+A1:2016 EU Reaction to Fire Performance criteria

Order No.	SAP No.	Description
CAA-00418	183020048	Cat6A U/FTP Gel Filled Outdoor PE Cable Nylon Fca Blue 305m

Copper Solutions PowerCat™ 6A Shielded



PowerCat 6A Pre-Terminated Cable Assemblies

Molex PowerCat 6A Shielded Pre-Term cable assemblies are ideal for use in data centers and high speed network environments. The PowerCat 6A pre-terminated shielded assemblies are designed to support secure-high speed 10GBASE-T and is backward compatible with 10/100/1000BASE-T networks. These cable assemblies are made from high quality Cat 6A U/FTP 4-pair shielded 23AWG solid copper wire and are pre-terminated to robust die cast zinc DataGate C6A shielded shuttered jack which provide superior alien crosstalk (AXT) suppression, and provides enhanced electromagnetic interference (EMI) protection. These pre-term cable assemblies are available as jack-to-jack, plug-to-jack, or plug-to-plug. The six individual cables are bundled together with spiral wrapping placed every metre

- Factory terminated and tested
- Up to 80% faster to install than traditional field installation
- Fully compliant with ISO/IEC 11801 Amd.1 and Amd.2 Ed. 2.0 Class EA
- Pre-terminated PowerCat 6A
- LS0H sheath
- 10G Performance when installed as a complete PowerCat 6A Shielded System
- RoHS Compliant
- Field AXT testing not required because cables are compliant by design
- Cable bundles with pulling eye available upon request .

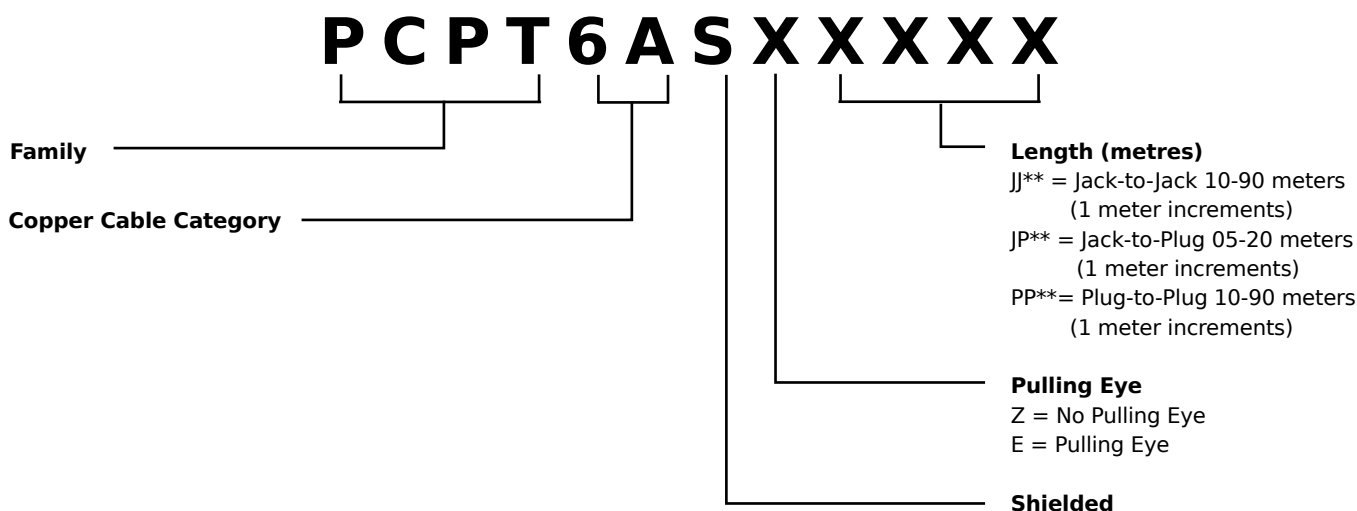

Example: to order a Cat 6A shielded jack-to-jack bundle of 6 cables 32 meter LS0H pre-term assembly without pulling eye, the part number would be PCPT6ASZJJ32

DataGate Unloaded Patch Panels (sold separately)

Order No.	SAP No.	Description
PID-00258	180810031	PowerCat 24 Port DataGate Patch Panel, Unloaded UTP or Shielded - 1U
PID-00259	180810032	PowerCat 24 Port DataGate Angled Patch Panel, Unloaded UTP or Shielded - 1U
PID-00260	180810033	PowerCat 48 Port DataGate Patch Panel, Unloaded UTP or Shielded - 2U
PID-00261	180810034	PowerCat 48 Port DataGate Angled Patch Panel, Unloaded UTP or Shielded - 2U

Copper Solutions PowerCat™ 6A Shielded



1U 24 Port, Angled Keystone Jack Aperture, Unloaded Patch Panel

The Molex 1U 24 Port patch panel with angled, staggered Keystone Jack apertures is ideal for high density installations which utilise side of rack/cabinet cable management. The angled port design orientates the shielded or UTP Keystone jack at 15 degrees while the panel itself is a linear design, rather than a V-shape. The staggered, angled jack positions eliminate the need for an additional cable management panel, while maintaining optimised patch cord bend radius. The innovative panel design maintains an even, level aesthetic in rack/cabinet layouts where a mix of active equipment and patch panels are included. The panel is finished in black with white port numbering for easy site administration, and is supplied with a robust rear cable management tray, designed to support 24 UTP or shielded cables. An earth cable is provided for shielded installations.

- Eliminates the need for an additional horizontal cable management panel
- Angled, staggered ports orient the jack at 15°
- Compatible with Molex Keystone Jacks (supplied separately, part numbers shown below)
- Supplied unloaded for maximum installation flexibility
- Maintains the even aesthetics of active equipment and panels within a cabinet or rack
- Comes complete with rear cable management, port identification and earth cable and is shipped with the necessary fixing kit

Order No.	SAP No.	Description
PID-00282	180810045	1U 24 Port, Angled Keystone Jack Aperture, Patch Panel - Unloaded

PowerCat 6A Tool-less Shielded Keystone Jack



The Shielded Tool-less C6A Keystone Jack is in addition to the PowerCat 6A STP product line designed for installation in Structured Cabling Systems requiring Keystone size apertures for wall outlet installations. The jack is terminated without the use of a Punch Down Tool. The jack is designed for use in a two-connector permanent link or channel configuration so the standard Molex C6A Shielded DataGate panels are installed in the Distribution closet and C6A Keystone Jacks are installed in the Telecommunication/Wall Outlets. The jack does not feature a dust shutter. This product provides excellent protection against electromagnetic interference protection due to its fully shielded 360° construction.

- 360° shielding for EMI protection
- Easy and fast termination process
- Ability to attach the cable in either 568A or 568B wiring
- Compatible with Molex C6 DataGate™ jacks in a two connector permanent link or channel configuration

Order No.	SAP No.	Description
KSJ-00079	Consult Molex	PowerCat 6A Tool-less shielded Keystone Jack, RJ45, 360°, 568A/B

Modular Keystone Jack Panel

The Molex 24 Port Modular Keystone Jack Panel is a flexible patching solution for small to medium size installations. The panel is shipped unloaded and can be configured to provide the exact number of ports required. The Keystone Jacks snap in easily and can be removed if required.

The patch panel features an integral rear cable management tray for ease of installation and cable dressing.

- Available in 24 Ports 1U
- Modularity provides installation flexibility
- Easy snap in Keystone Jacks
- Rear cable management included
- Accepts UTP and Shielded Keystone Jacks



Order No.	SAP No.	Description
PID-00257	182960014	Keystone Jack Panel, 24 port, Unloaded - 1U

Copper Solutions

PowerCat™ 6A Shielded



PowerCat 6A Euromod™ II Module

The Euromod modular system provides a flexible and versatile method of installation, allowing the user the choice of installing as many data outlets as required. Compatible with the Euromod range of wallplates, the module is supplied with a protected label facility and the angled design reduces patch cord bend radius. The product is shipped complete with the shielded C6A DataGate jack and 25 x 50mm fascia. Individual ports may be colour coded for site-specific network administration by fitting connector icon labels (part no. CSP-00021-0**).

- Protected labelling facility
- 22 x 50mm fascia
- Compatible with Euromod wallplates
- Supplied with DataGate C6A jack

Order No.	SAP No.	Description
MEU-00065-02	0183010005	PowerCat 6A Angled Euromod II RJ45 Module, 568A/B - White
MEU-00065-04	0183010012	PowerCat 6A Angled Euromod II RJ45 Module, 568A/B - Black
MEU-00070-**	Consult Molex	PowerCat 6A Angled Side Entry Euromod II Module, RJ45 568A/B, Shielded

** Colour Options - 02 = White, 04 = Black



PowerCat 6A MOD-SNAP™ III Module

The MOD-SNAP III Module is ideal for UK floor box applications and may be used with the MOD-SNAP wallplate range. The module is supplied with a protected label facility and the angled design reduces patch cord bend radius. The product is shipped complete with the shielded C6A DataGate™ jack and the 38.5 x 25mm (BT6C size) fascia.

- Protected labelling facility
- UK floorbox compatible
- Compatible with MOD-SNAP wallplates
- Supplied with DataGate C6A jack

Order No.	SAP No.	Description
MMS-00017-02	0183010003	PowerCat 6A Angled MOD-SNAP III RJ45 Module, 568A/B - White
MMS-00017-04	0183010011	PowerCat 6A Angled MOD-SNAP III RJ45 Module, 568A/B - Black
MMS-00019-**	Consult Molex	PowerCat 6A Angled Side Entry MOD-SNAP III Module RJ45 568B, Shielded

** Colour Options - 02 = White, 04 = Black



PowerCat 6A Legrand® Compatible Module

These PowerCat 6A shielded modules are compatible with the Legrand range of 45 x 45mm bezels. The angled design reduces patch cord bend radius and features a protected labelling feature. Individual ports may be colour coded using a connector icon, for site-specific network administration.

- Protected labelling facility
- 22.5 x 45mm & 45 x 45mm fascia
- Compatible with Legrand Mosaic™ wallplates (not supplied)
- Supplied with DataGate C6A jack
- Available in either traditional rear or side entry variations
- Side entry jack allows cable termination either side

Order No.	SAP No.	Description
MLG-00030-**	183010006	PowerCat 6A 22.5 x 45mm Legrand compatible Module
MLG-00031-**	183010007	PowerCat 6A 45 x 45mm Legrand compatible Module
MLG-00034-**	Consult Molex	PowerCat 6A 45 x 45mm Side Entry Module RJ45 568A/B
MLG-00035-**	Consult Molex	PowerCat 6A 22.5 x 45mm Side Entry Module RJ45 568A/B

** Colour Options - 02 = White, 04 = Black

Copper Solutions

PowerCat™ 6A Shielded



PowerCat 6A DIN Module

The PowerCat 6A DIN module is compatible with the 50 x 50mm DIN 49075 standard. Available as single or dual ports, the modules are supplied with a protected label facility and the angled design reduces patch cord bend radius. The product is shipped complete with the shielded C6A DataGate jack. Individual ports may be colour coded for site-specific network administration by fitting connector icon labels (part no. CSP-00021-0**).

- Protected labelling facility
- 50 x 50mm fascia
- DIN 49075 compatible
- Supplied with DataGate C6A jack
- 1 and 2 Port versions
- Available in either traditional rear or side entry variations
- Side entry jack allows cable termination either side

Order No.	SAP No.	Description
WNC-00044-**	Consult Molex	PowerCat 6A 1 Port DIN Module Shielded
WNC-00045-**	Consult Molex	PowerCat 6A 2 Port DIN Module Shielded
WNC-00050-**	Consult Molex	PowerCat 6A Side Entry DIN Module 1 Port DataGate RJ45 568A/B Shielded
WNC-00051-**	Consult Molex	PowerCat 6A Side Entry DIN Module 2 Port DataGate RJ45 568A/B Shielded

** Colour Options - 06 = Almond, 02 = White

PowerCat 6A Synergy™ Surface Box

The Shielded PowerCat 6A Synergy Surface Box is ideal for use in open office cabling. Synergy Surface Boxes offer simple and organised installation in areas where surface mount is the only option. Cable can be installed from the sides or base of the box. Individual ports can also be colour coded for site-specific network administration using connector icon labels.

- Stylish design
- Simple, organised cable entry and installation
- Screw fixing
- Clear and concise labelling
- Compatible with DataGate Jacks



Order No.	SAP No.	Description
SBX-00009-02	Consult Molex	PowerCat 6A 1 Port Synergy Surface Box RJ45 568A/B Shielded - White (loaded)
SSY-00014-02	181340013	PowerCat 6A 2 Port Synergy Surface Box, Unloaded - White
SSY-00015-02	181340016	PowerCat 6A 4 Port Synergy Surface Box, Unloaded - White
SSY-00016-02	181340019	PowerCat 6A 6 Port Synergy Surface Box, Unloaded - White

PowerCat 6A MOD-Clip™ DataGate Jacks

The PowerCat 6A MOD-Clip DataGate jack offers superior alien crosstalk suppression, excellent insertion loss, and provides enhanced electromagnetic interference (EMI) protection by utilising robust die-cast zinc alloy connector body housing. This shielded connector also features a unique spring-loaded shutter that not only protects it from dust and contaminants, but the ingenious spring-loaded design also ejects improperly seated patch cords. The shielded connector is dual colour coded for either 568A or 568B wiring schedules.

- ETL Verified
- Robust die-cast zinc alloy housing
- Dual Colour coding allows 568A/B wiring
- Patented IDC V-Shaped contacts that flex not fatigue when terminated
- Spring-Loaded Shutter
- Accepts colour coded port identification labels
- RoHS Compliant
- Spring loaded cable/drain wire clamp
- Designed for use with Molex's MOD-Clip wallplates
- Designed to fit the Clipsal®, HPM® system of wallplates



Order No.	SAP No.	Description
MMC-00017-02	0183010020	PowerCat 6A MOD-Clip Shielded Jack 8W 568 A/B White
MMC-00017-04	0183010019	PowerCat 6A MOD-Clip Shielded Jack 8W 568 A/B Black
MMC-00020-**	Consult Molex	PowerCat 6A Side Entry MOD-Clip DataGate Jack, RJ45, 568A/B Shielded

** Colour Options - 02 = White, 04 = Black

Copper Solutions PowerCat™ 6 UTP

Molex's Category 6 Product Range, PowerCat 6, is designed to meet or exceed the requirements of current international standards.

The solution features cable, patch cords, patch panels and wall outlet solutions suitable for a wide range of territorial requirements.

PowerCat 6 U/UTP Cable

PowerCat 6 4 pair cable has been designed to support high-speed data transmission systems. The cable features a cross-member designed to keep individual pairs separated for the reduction of NEXT and ELFEXT. The cable is available in PVC and LS0H sheaths on 500m reels and 305m reel in a box.

- Unshielded 4 Pair PVC and LS0H Cable
- Central separator for the reduction of NEXT & ELFEXT
- Colour coded pairs for ease of termination
- Independently tested
- 500m reel and 305m reel in a box
- Compliant with EN 50575:2014+A1:2016 EU Reaction to Fire Performance criteria



Order No.	SAP No.	Description
CAA-00302	181740038	PowerCat 6 U/UTP PVC Cable Eca Grey - 305m reel in a box
CAA-00305	181740056	PowerCat 6 U/UTP LS0H Cable Dca-s2,d2,a1 Violet - 305m reel in a box
CAA-00326	181740058	PowerCat 6 U/UTP PVC Cable Eca Grey - 500m Reel
CAA-00325	181740057	PowerCat 6 U/UTP LS0H Cable Dca-s2,d2,a1 Violet - 500m
CAA-0336-VL	Consult Molex	PowerCat 6 LS0H Cable B2ca-s1a,d1,a1 - 305m Reel in a Box

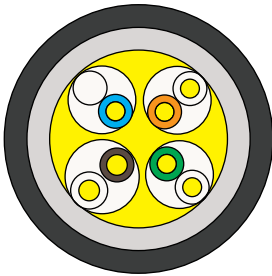

Category 6 U/UTP Gel-Filled Outdoor Cable Nylon Sheath

The Molex outside plant gel-filled Category 6 4 Pair U/UTP cable utilises a HDPE compound which insulates the cores while a PE (UV) sheath provides protection against moisture and UV. An additional nylon outer jacket provides protection against abrasion and termites. The rugged construction of this cable makes it ideal for outdoor/underground installations.

- Category 6 compliant
- PE (UV) and nylon sheathed for greater protection
- UV resistant
- Suitable for outdoor/underground installations
- Water resistant gel-filled design
- Compliant with EN 50575:2014+A1:2016 EU Reaction to Fire Performance criteria

Order No.	SAP No.	Description
CAA-00419-OH	181740138	Cat6 U/UTP Gel Filled Outdoor PE Cable Nylon Fca Blue 305 m

PowerCat 6 UTP DataGate™ Jack

The DataGate Jack is the cornerstone of the Molex Premise Networks PowerCat 6 System performance.

This jack features a unique spring-loaded shutter that not only protects it from dust and contaminants, but the ingenious spring-loaded design also ejects improperly seated patch cords. The product is dual colour coded for either 568A or 568B wiring schedules and is backwards compatible with C5e systems.

- Dual Colour coding allows 568A/B wiring
- Patented IDC V-Shaped contacts that flex not fatigue when terminated
- Patented spring-loaded shutter
- RJ-11 compatible
- Accepts colour coded port identification labels
- Molex 4 Pair Termination Tool or industry standard 110 termination tool compatible

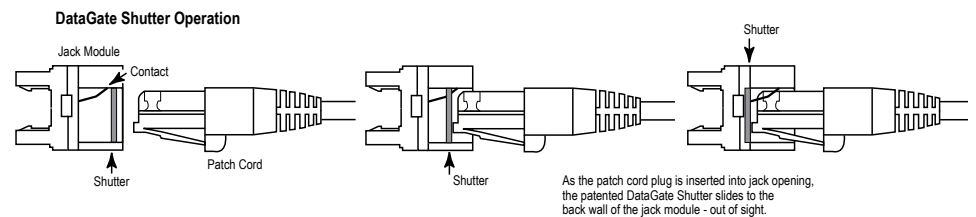

Order No.	SAP No.	Description
KSJ-00018-**	Consult Molex	PowerCat 6 DataGate Jack 8W 568A/B

** Colour Options - 02 = White, 04 = Black

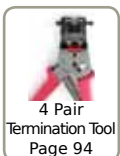

Copper Solutions PowerCat™ 6 UTP



PowerCat 6 MOD-Clip™ DataGate™ Jack

The MOD-Clip DataGate jack is designed to maintain clean and secure connections. The RJ45 jack features a patented spring-loaded shutter which protects it from dust and contaminants as well as providing tactile feedback. The spring-loaded shutter pops out an improperly seated patch cord - all with single-handed plug-in and removal. Available in seven colours, MOD-Clip DataGate jacks utilise patented IDC V-shaped contacts that flex not fatigue when terminated.

- Patented spring-loaded shutter prevents incomplete mating
- IDC contacts that flex not fatigue when terminated
- Pointed IDC towers to speed termination and enhance cable retention
- 568 A/B wiring configuration
- Allows rear and side entry cable termination
- RoHS Compliant
- Designed to fit the Clipsal®, HPM® and PDL® system of wallplates

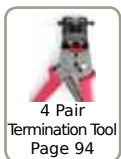

Order No.	SAP No.	Description
MMC-00010-**	Consult Molex	PowerCat 6 MOD-Clip DataGate Jack 568 A/B

** Colour Options - 02 = White, 04 = Black, 08 = Light Grey, RD = Red, BL = Blue, GR = Green, YL = Yellow



Keystone Jack

Utilising patented IDC V-shaped contacts that flex not fatigue when terminated, the RJ-45 Keystone Jack is compatible with any product that accepts the standard keystone profile.

- Dual Colour coding allows 568A/B wiring
- Patented IDC V-Shaped contacts that flex not fatigue when terminated
- Features pointed IDC towers to speed termination and enhance cable retention
- RJ-11 & RJ-12 compatible
- Moulded category identification on jack face
- Molex 4 Pair Termination Tool or industry standard 110 termination tool compatible

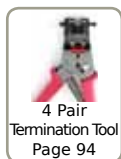

Order No.	SAP No.	Description
KSJ-00033-**	Consult Molex	Keystone Jack, Category 6, 8W, 568A/B

** Colour Options - 01 = Almond 02 = White 04 = Black

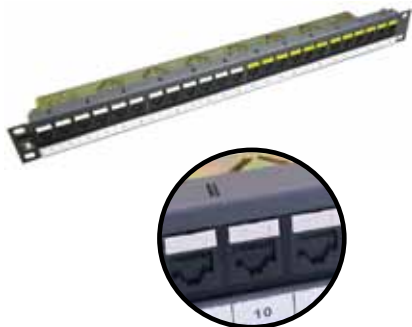

PowerCat 6 Patch Panels

PowerCat 6 Patch Panels feature the shuttered DataGate Connector which is dual colour coded for either 568A or 568B wiring. The panels come complete with an integral cable management tray for cable strain relief and tidy cable dressing. Available in 24 or 48 port versions, with front and rear port labelling. Individual ports can be colour coded using an icon for site-specific network administration.

- Shuttered DataGate™ RJ45
- 24 Port 1U, 48 Port 2U
- EIA 568A/B colour coded
- Integral rear cable management tray
- Standard 19" rack mount
- Graphite grey finish

Order No.	SAP No.	Description
PID-00141	182040009	PowerCat 6 24 Port Patch Panel RJ45 568A/B UTP - 1U
PID-00142	182040010	PowerCat 6 48 Port Patch Panel RJ45 568A/B UTP - 2U

Copper Solutions PowerCat™ 6 UTP



PowerCat 6 Angled Patch Panels

Angled Patch Panels are ideal for installations of high density or which utilise extensive side and end-of-the-rack cable management. The angled feature provides enhanced port access and minimises patch cord bend radius to the rack. Each port features a patented spring-loaded shutter and can be colour coded using an icon for site specific network administration. The panel provides both front and rear port number identification.

- Shuttered DataGate™ RJ45
- 24 Ports 1U & 48 Port 2U
- Category 6 performance
- EIA 568A/B wired
- Standard 19" rack mount
- Individually removable patch panel ports
- Integral cable rear management

Order No.	SAP No.	Description
PID-00156	182080297	PowerCat 6 24 Port Angled Patch Panel RJ45 568A/B UTP - 1U
PID-00157	182080299	PowerCat 6 48 Port Angled Patch Panel RJ45 568A/B UTP - 2U



PowerCat Unloaded DataGate Panels

The Molex PowerCat Unloaded DataGate Patch Panels can be configured to provide the exact number of modular ports required. DataGate Category 5e UTP, Category 6 UTP, or Category 6A shielded jacks can be terminated to cable and then snapped into this DataGate patch panel. The patch panel and rear cable manager are constructed of cold-rolled steel for strength and durability.

- Available in 1U 24P Flat, 1U 24P Angled, 2U 48P Flat, 2U 48P Angled
- Easy snap in DataGate UTP or Shielded Jacks (sold separately)
- Modularity provides installation flexibility
- Front portable labelling
- Individually removable patch panel ports
- Removable cable management shelf ensures bend radius compliance
- ANSI and metric hardware kit included
- Grounding screws included

Order No.	SAP No.	Description
PID-00258	180810031	PowerCat 24 Port DataGate Patch Panel, Unloaded UTP or Shielded - 1U
PID-00259	180810032	PowerCat 24 Port DataGate Angled Patch Panel, Unloaded UTP or Shielded - 1U
PID-00260	180810033	PowerCat 48 Port DataGate Patch Panel, Unloaded UTP or Shielded - 2U
PID-00261	180810034	PowerCat 48 Port DataGate Angled Patch Panel, Unloaded UTP or Shielded - 2U
KSJ-00005-0*	Consult Molex	Single Position Blank Module (Bag of 25)

* Colour Options - 2 = White, 4 = Black



1U 24 Port, Angled Aperture, Keystone Jack Unloaded Patch Panel

The Molex 1U 24 Port patch panel with angled, staggered Keystone Jack apertures is ideal for high density installations which utilise side of rack/cabinet cable management. The angled port design orientates the shielded or UTP Keystone jack at 15 degrees while the panel itself is a linear design, rather than a V-shape. The staggered, angled jack positions eliminate the need for an additional cable management panel, while maintaining optimised patch cord bend radius. The innovative panel design maintains an even, level aesthetic in rack/cabinet layouts where a mix of active equipment and patch panels are included.

The panel is finished in black with white port numbering for easy site administration, and is supplied with a robust rear cable management tray, designed to support 24 UTP or shielded

cables. An earth cable is provided for shielded installations. The product is compatible with Molex Keystone Jacks (supplied separately) and is shipped with the necessary fixing kit.

- Eliminates the need for an additional horizontal cable management panel
- Angled, staggered ports orient the jack at 15 degrees
- Compatible with Molex Keystone Jacks (supplied separately)
- Supplied unloaded for maximum installation flexibility
- Maintains the even aesthetics of active equipment and panels within a cabinet or rack
- Comes complete with rear cable management, port identification and earth cable

Order No.	SAP No.	Description
PID-00282	180810045	Patch panel 1 U 24 Port. Angled aperture, Keystone Jack, Unloaded

Copper Solutions PowerCat™ 6 UTP



Modular Keystone Jack Panel

The Molex 24 Port Modular Keystone Jack Panel is a flexible patching solution for small to medium size installations. The panel is shipped unloaded and can be configured to provide the exact number of ports required. The Keystone Jacks snap in easily and can be removed if required.

The patch panel features an integral rear cable management tray for ease of installation and cable dressing.

- Available in 24 Ports 1U
- Modularity provides installation flexibility
- Easy snap in Keystone Jacks
- Rear cable management included
- Accepts UTP and Shielded Keystone Jacks

Order No.	SAP No.	Description
PID-00257	182960014	Keystone Jack Panel, 24 port, Unloaded - 1U



PowerCat Unloaded DataGate Adapter Plate

The Unloaded Adapter Plate 3 x DataGate Jacks is designed for applications where fibre and copper are required in a single panel. The Adapter Plate is designed to accept the DataGate UTP Jack and snap fits into the Multi-Functional or Specification Grade Fibre Optic Panels. The Adapter Plate can also be combined with Fibre Optic 6 Fibre Adapter Plates for multi-media applications.

- Accommodates 3 x DataGate Jacks
- For use within Molex Multi-Functional or Specification Grade Fibre Panels
- Allows multi-media flexibility within a single enclosure/panel

Order No.	SAP No.	Description
AFR-00440	183190030	Adapter Plate 3 x PowerCat DataGate unloaded



PowerCat 6 Consolidation Point Enclosures

Consolidation Points provide increased flexibility and economy for installations where open office spaces require frequent re-configuration. They feature 6 or 8 shuttered PowerCat 6 modules and allow ready access to the Solid Cable Assembly Links. The product is TIA/EIA TSB75 compliant. Two enclosures may be interconnected, allowing for expansion.

- Allows moves, adds and changes without re-terminating and re-testing of cable
- 6 or 8 port DataGate modules
- Rugged graphite grey enclosure
- TSB 75 compliant

Order No.	SAP No.	Description
CPT-00032	0180080065	PowerCat 6 6 Port Consolidation Point Enclosure RJ45 568B UTP
CPT-00033	0180080073	PowerCat 6 8 Port Consolidation Point Enclosure RJ45 568B UTP

Copper Solutions PowerCat™ 6 UTP

PowerCat 6 Synergy™ Surface Boxes

Synergy Surface Boxes are ideal for use in open office cabling. The attractive contemporary designed product family comprises of 1, 2, 4 and 6 port variants complete with DataGate shuttered connectors. Synergy Surface Boxes offer simple, organised installation in areas where surface mount is the only option. Cable can be installed from the sides or base of the box. Individual ports can also be colour coded for site-specific network administration using connector icon labels.

- Stylish design
- Simple, organised cable entry and installation
- Screw fixing
- Clear and concise labelling
- DataGate Jacks included



Order No.	SAP No.	Description
SBX-00005-02	181770326	PowerCat 6 1 Port Synergy Surface Box RJ45 568A/B UTP - White
SSY-00007-02	181770323	PowerCat 6 2 Port Synergy Surface Box RJ45 568A/B UTP - White
SSY-00008-02	181770324	PowerCat 6 4 Port Synergy Surface Box RJ45 568A/B UTP - White
SSY-00009-02	181770325	PowerCat 6 6 Port Synergy Surface Box RJ45 568A/B UTP - White



PowerCat 6 Angled MOD-SNAP™ III Module

The angled MOD-SNAP III Module is ideal for floor box applications. The product is a fully assembled unit featuring the shuttered DataGate™ connector. The angled design reduces patch cord bend radius particularly in shallow floor box installations. The angled MOD-SNAP Module can also be used in the MOD-SNAP range of wallplates.

- Shuttered RJ45 DataGate connector
- Protected labelling facility
- Floor box and wallplate compatible
- 38.5 x 25mm fascia (BT6C size)

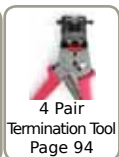
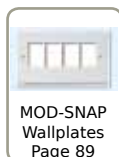

Order No.	SAP No.	Description
MMS-00013-02	0181780003	PowerCat 6 Angled MOD-SNAP III Module RJ45 568A/B UTP
MMS-00014-02	0181170009	MOD-SNAP Module Blank

** Colour Options - 02 = White 04 = Black



PowerCat 6 Contura™ Module

The Contura product family is designed to combine aesthetics with functionality. The PowerCat 6 Contura module is a fully assembled unit featuring the shuttered DataGate connector. The angled design of the module reduces patch cord bend radius and features a protected labelling facility. Individual ports may be colour coded for site-specific network administration by fitting connector icon labels.

- Contemporary design
- Shuttered RJ45 DataGate Module
- Protected labelling facility
- Module and Blank 22 x 50mm



Order No.	SAP No.	Description
MGB-00001-02	0181770082	PowerCat 6 Angled Contura Module RJ45 568A/B UTP - White
MGB-00002-02	0181770216	Contura Module Blank - White

Copper Solutions PowerCat™ 6 UTP



PowerCat 6 Euromod™ II Module

The Euromod modular system provides a flexible and versatile method of installation, allowing the user the choice of installing as many data outlets as required. The modules are fully assembled units featuring the Molex shuttered DataGate™ connector in a 25 x 50mm fascia. Individual ports can also be colour coded for site-specific network administration using connector icon labels.

- Shuttered RJ45 DataGate connector
- 25 x 50mm fascia
- Individual port colour coding option

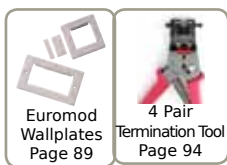

Euromod Wallplates
Page 89

4 Pair Termination Tool
Page 94

Order No.	SAP No.	Description
MEU-00056-02	0181730016	PowerCat 6 Euromod II Module RJ45 568A/B UTP - White
MEU-00056-04	0181730017	PowerCat 6 Euromod II Module RJ45 568A/B UTP - Black
17-0412-02	0180060060	Euromod Quarter (12.5 x 50mm) Blank - White
17-0413-02	0181370005	Euromod Half (25 x 50mm) Blank - White
17-0414-02	0180060062	Euromod Full (50 x 50mm) Blank - White



PowerCat 6 Legrand® Compatible Module

The PowerCat 6 22.5 x 45mm and 45 x 45mm modules are compatible with the Legrand Mosaic™ range of 45 x 45mm bezels. Two modules or a single module and a blank may be installed in this format. The product is a fully assembled unit featuring the shuttered DataGate™ connector. The angled design reduces patch cord bend radius and features a protected labelling facility. Individual ports may be colour coded using a connector icon for site-specific network administration.

- Legrand Mosaic 45 x 45mm bezel compatible
- Shuttered RJ45 DataGate connector
- Protected labelling facility
- Angled fascia



Label Kits
Page B-29

4 Pair Termination Tool
Page 94

Order No.	SAP No.	Description
MLG-00021-02	188000016	PowerCat 6 22.5 x 45mm Legrand Compatible Module RJ45 568A/B UTP - White
MLG-00024-02	188000068	PowerCat 6 45 x 45mm Legrand Compatible Module RJ45 568A/B UTP - White
16.A0012	180070055	22.5 x 45mm Blank Module - White



PowerCat 6 DIN Module

The PowerCat 6 DIN module is designed for compatibility with the 50 x 50mm DIN 49075 standard. The product is a fully assembled unit featuring the shuttered DataGate connector. The angled design reduces patch cord bend radius and features a protected labelling facility. Individual ports may be colour coded using a connector icon label for site-specific network administration. The PowerCat 6 DIN module is available as a single or double port product and is supplied with a grid-plate.

- DIN 49075 compatible
- Shuttered RJ45 DataGate connector
- Protected labelling facility
- Angled fascia
- 1 and 2 Port versions

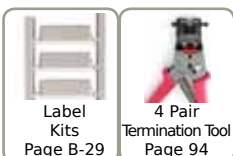

Label Kits
Page B-29

4 Pair Termination Tool
Page 94

Order No.	SAP No.	Description
WNC-00030-02	180410071	PowerCat 6 1 Port DIN Module RJ45 568A/B UTP - White
WNC-00031-02	180410073	PowerCat 6 2 Port DIN Module RJ45 568A/B UTP - White

Copper Solutions PowerCat™ 6 UTP



PowerCat 6 U/UTP Patch Cords

Molex PowerCat 6 U/UTP Patch Cords are key components of PowerCat 6 U/UTP End-to-End Solution. The PowerCat 6 Patch Cords are designed to support data networks for 10/100BASE-T and 1000BASE-T applications. The patch cable is made from high quality four pair 24 AWG stranded copper wire. Available in a range of colours and lengths, PowerCat 6 Patch Cords are pre-terminated with RJ45 plugs and feature anti-slag slim strain relief slip on boots.

- 4 pair 24 AWG stranded wire
- Pre-terminated with WE8W plugs
- Slim clear anti-slag slip on boots
- Suitable for EIA 568A or 568B wiring applications
- LS0H sheath
- RoHS Compliant

Order No.	SAP No.	Description
PCD-02000-**-	Consult Molex	PowerCat 6 U/UTP Patch Cord LS0H - 0.5m
PCD-02001-**-	Consult Molex	PowerCat 6 U/UTP Patch Cord LS0H - 1m
PCD-02002-**-	Consult Molex	PowerCat 6 U/UTP Patch Cord LS0H - 1.5m
PCD-02003-**-	Consult Molex	PowerCat 6 U/UTP Patch Cord LS0H - 2m
PCD-02005-**-	Consult Molex	PowerCat 6 U/UTP Patch Cord LS0H - 3m
PCD-02009-**-	Consult Molex	PowerCat 6 U/UTP Patch Cord LS0H - 5m
PCD-02013-**-	Consult Molex	PowerCat 6 U/UTP Patch Cord LS0H - 7m
PCD-02019-**-	Consult Molex	PowerCat 6 U/UTP Patch Cord LS0H - 10m

** Colour Options - 0C = Red, 0E = Grey, 0H = Blue, 0J = Green, 0K = Yellow, 0W = White, 0P = Purple, 0N = Orange, BK = Black
Standard Stocked Colours - Grey, Red, Blue. All other colours and lengths may be subject to MOQ's, longer lead times and variable pricing.
Standard Stocked Lengths - 1, 2, 3, 5, 7, 10 metres

PowerCat 6 Solid Cable Assemblies

PowerCat 6 Solid U/UTP Cable Assemblies are designed for implementation in Category 6 installations, where Consolidation Points or Cross Connect equipment cords are required. The product is available in PVC and LS0H Solid Cable to meet all requirements within LAN and Data Centre environments.

- Category 6 performance
- PVC and LS0H versions
- 100% Factory Tested
- Strain relief boots for protection against cable tension



Order No.	SAP No.	Description
PCD-00456-0E	Consult Molex	PowerCat 6 U/UTP Solid Cable Patch Cord Assembly PVC Eca Grey 4m
PCD-00457-0E	Consult Molex	PowerCat 6 U/UTP Solid Cable Patch Cord Assembly PVC Eca Grey - 6m
PCD-00458-0E	Consult Molex	PowerCat 6 U/UTP Solid Cable Patch Cord Assembly PVC Eca Grey - 8m
PCD-00459-0E	Consult Molex	PowerCat 6 U/UTP Solid Cable Patch Cord Assembly PVC Eca Grey - 10m
PCD-00460-0E	Consult Molex	PowerCat 6 U/UTP Solid Cable Patch Cord Assembly PVC Eca Grey - 20m
PCD-00461-0E	Consult Molex	PowerCat 6 U/UTP Solid Cable Patch Cord Assembly PVC Eca Grey - 30m
PCD-00462-0E	Consult Molex	PowerCat 6 U/UTP Solid Cable Patch Cord Assembly PVC Eca Grey - 40m

Order No.	SAP No.	Description
PCD-00464-0P	0181880025	PowerCat 6 U/UTP Solid Cable Patch Cord Assembly LS0H VL Dca-s2,d2,a1 4m
PCD-00465-0P	0181880026	PowerCat 6 U/UTP Solid Cable Patch Cord Assembly LS0H VL Dca-s2,d2,a1 6m
PCD-00466-0P	0181880027	PowerCat 6 U/UTP Solid Cable Patch Cord Assembly LS0H VL Dca-s2,d2,a1 8m
PCD-00467-0P	0181880028	PowerCat 6 U/UTP Solid Cable Patch Cord Assembly LS0H VL Dca-s2,d2,a1 10m
PCD-06000-0P	0181880037	PowerCat 6 U/UTP Solid Cable Patch Cord Assembly LS0H VL Dca-s2,d2,a1 15m
PCD-00468-0P	0181880029	PowerCat 6 U/UTP Solid Cable Patch Cord Assembly LS0H VL Dca-s2,d2,a1 20m
PCD-06001-0P	0181880038	PowerCat 6 U/UTP Solid Cable Patch Cord Assembly LS0H VL Dca-s2,d2,a1 25m
PCD-00469-0P	0181880030	PowerCat 6 U/UTP Solid Cable Patch Cord Assembly LS0H VL Dca-s2,d2,a1 30m
PCD-060021-0P	0181880039	PowerCat 6 U/UTP Solid Cable Patch Cord Assembly LS0H VL Dca-s2,d2,a1 35m
PCD-00470-0P	0181880031	PowerCat 6 U/UTP Solid Cable Patch Cord Assembly LS0H VL Dca-s2,d2,a1 40m
PCD-00471-0P	0181880032	PowerCat 6 U/UTP Solid Cable Patch Cord Assembly LS0H VL Dca-s2,d2,a1 50m
PCD-00472-0P	0181880033	PowerCat 6 U/UTP Solid Cable Patch Cord Assembly LS0H VL Dca-s2,d2,a1 60m

Copper Solutions PowerCat™ 6 Shielded



PowerCat 6 F/UTP Cable

PowerCat 6 F/UTP 4 Pair cable has been designed to support Category 6 transmission systems. The four twisted pairs and drain-wire are enclosed in a shielding foil. A cross-member is provided to keep individual pairs separated for the reduction of NEXT and ELFEXT. The cable is available in PVC and LS0H sheaths on 500m reels.

- Shielded 4 pair PVC and LS0H cable
- Central separator for the reduction of NEXT & ELFEXT
- Colour coded for ease of termination
- 500 metre reel
- Compliant with EN 50575:2014+A1:2016 EU Reaction to Fire Performance criteria

Order No.	SAP No.	Description
CAA-00161	0181750036	PowerCat 6 F/UTP PVC Cable Eca Grey - 500m
CAA-00251	0181750035	PowerCat 6 F/FTP LS0H Cable Dca-s2,d2,a1 Violet - 500m



PowerCat 6 DataGate Jack

The DataGate Jack is the cornerstone of the Molex Premise Networks PowerCat 6 shielded system performance. The jack provides 360° shielded protection by utilising a two piece tin/nickel plated brass can that encloses the jack.

This shielded jack features a unique spring-loaded shutter that not only protects it from dust and contaminants, but the ingenious spring-loaded design also ejects improperly seated patch cords. The product is dual colour coded for either 568A or 568B wiring schedules and is backwards compatible with C5e systems.

- 360° shielded RJ45 jack
- Dual Colour coding allows 568A/B wiring
- Patented IDC V-Shaped contacts that flex not fatigue when terminated
- Patented spring-loaded shutter
- RJ-11 compatible
- Accepts colour coded port identification labels
- Supplied with all PowerCat 6 patch panels and wall outlets
- Molex 4 Pair Termination Tool or industry standard 110 termination tool compatible

DataGate Shutter Operation

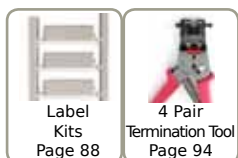
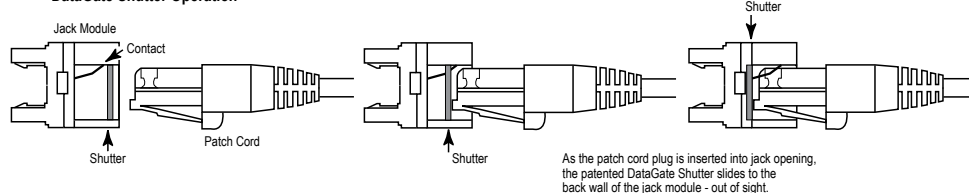

Order No.	SAP No.	Description
KSJ-00035-02	Consult Molex	PowerCat 10G DataGate Jack RJ45 568A/B Shielded-White shutter
KSJ-00035-04	Consult Molex	PowerCat 10G DataGate Jack RJ45 568A/B Shielded-Black shutter

PowerCat 6 Shielded DataGate Patch Panel

The PowerCat 6 Shielded Patch Panel features the shuttered shielded DataGate connector, which is dual colour coded for either 568A or 568B wiring. The panel comes complete with an integral cable management tray for cable strain relief and tidy cable dressing. Port numbering is provided on the front and rear of the panel and individual ports may be colour coded using connector icon labels for site-specific network administration.

- 24 Ports 1U
- Rear cable management included
- Colour coded port option
- 360° shielded shuttered DataGate connector
- 568A/B wiring schedule
- Graphite grey finish

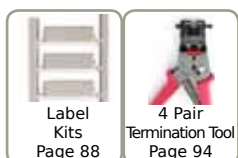

Order No.	SAP No.	Description
PID-00182	0181520015	PowerCat 6 24 Port Patch Panel 568A/B Shielded - 1U

Copper Solutions PowerCat™ 6 Shielded



PowerCat 6 Shielded Euromod™ II Module

The Shielded Euromod modular system provides a flexible and versatile method of installation, allowing the user the choice of installing as many data outlets as required. The module is compatible with the Euromod range of wallplates and its angled design reduces patch cord bend radius. The Shielded Angled Euromod II module features the shuttered shielded DataGate jack and 25 x 50mm fascia.

- 25 x 50mm fascia
- 360° shielded shuttered RJ45 DataGate connector
- Protected labelling facility
- Euromod wallplate compatible
- Angled fascia



Euromod Wallplates
Page 89

Label Kits
Page 88

4 Pair Termination Tool
Page 94

Order No.	SAP No.	Description
MEU-00058-02	0181790002	PowerCat 6 Angled Euromod II RJ45 568A/B Shielded - White
MEU-00058-04	0181790003	PowerCat 6 Angled Euromod II RJ45 568A/B Shielded - Black

PowerCat 6 Shielded Legrand® Compatible Module

The PowerCat 6 Shielded 22.5 x 45mm and 45 x 45mm modules are compatible with the Legrand Mosaic™ range of 45 x 45mm bezels. Two modules or a single module and a blank may be installed in this format. The product is a fully assembled unit featuring the shielded shuttered DataGate connector. The angled design reduces patch cord bend radius and features a protected labelling facility. Individual ports may be colour coded using a connector icon for site-specific network administration.

- Legrand bezel compatible
- 360° shielded shuttered RJ45 DataGate connector
- Protected labelling facility
- Angled fascia



Label Kits
Page 88

4 Pair Termination Tool
Page 94

Order No.	SAP No.	Description
MLG-00022-02	Consult Molex	PowerCat 6 22.5 x 45mm Legrand Compatible Module RJ45 568A/B Shielded - White
MLG-00025-02	188000069	PowerCat 6 45 x 45mm Legrand Compatible Module RJ45 568A/B Shielded - White
16.A0012	180070055	22.5 x 45mm Blank Module - White

PowerCat 6 Shielded DIN Module

The PowerCat 6 Shielded DIN module is designed for compatibility with the 50 x 50mm DIN 49075 standard. The product is a fully assembled unit featuring the shuttered shielded DataGate connector. The angled design reduces patch cord bend radius and features a protected labelling facility. Individual ports may be colour coded using a connector icon label for site-specific network administration. The PowerCat 6 Shielded DIN module is available as a single or double port product and is supplied with a grid-plate.

- DIN 49075 compatible
- 1 and 2 Port versions
- 360° shielded shuttered RJ45 DataGate connector
- Protected labelling facility
- Angled fascia

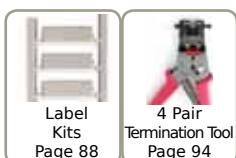

Label Kits
Page 88

4 Pair Termination Tool
Page 94

Order No.	SAP No.	Description
WNC-00036-**	Consult Molex	PowerCat 6 1 Port DIN Module RJ45 568A/B Shielded
WNC-00037-**	Consult Molex	PowerCat 6 2 Port DIN Module RJ45 568A/B Shielded

** Colour Options - 02 = White, 06 = Almond

Copper Solutions PowerCat™ 6 Shielded



PowerCat 6 Shielded Patch Cords

Molex PowerCat 6 Patch Cords are designed to support high speed networks. The patch cable is made from high quality four pair 26 AWG stranded copper wire. Available in a range of colours and lengths, PowerCat 6 patch cords are preterminated with RJ45 plugs and feature anti-slag slim strain relief slip on boots.

- 4 pair 26 AWG stranded copper wire
- Pre-terminated with RJ45 plugs
- Slim clear anti-slag slip on boots
- Suitable for EIA 568A or 568B wiring
- LS0H sheath
- RoHS Compliant

Order No.	SAP No.	Description
PCD-04001-**	Consult Molex	PowerCat 6 Patch cord, F/UTP, RJ45, 568B, Stranded, LS0H - 1m
PCD-04003-**	Consult Molex	PowerCat 6 Patch cord, F/UTP, RJ45, 568B, Stranded, LS0H - 2m
PCD-04005-**	Consult Molex	PowerCat 6 Patch cord, F/UTP, RJ45, 568B, Stranded, LS0H - 3m
PCD-04009-**	Consult Molex	PowerCat 6 Patch cord, F/UTP, RJ45, 568B, Stranded, LS0H - 5m
PCD-04013-**	Consult Molex	PowerCat 6 Patch cord, F/UTP, RJ45, 568B, Stranded, LS0H - 7m
PCD-04019-**	Consult Molex	PowerCat 6 Patch cord, F/UTP, RJ45, 568B, Stranded, LS0H - 10m

* Colour Options - 0C=Red, 0E=Grey, 0H=Blue, 0J=Green, 0K=Yellow

Copper Solutions PowerCat™ 5e UTP

Molex's Category 5e product range is known as the PowerCat system and is designed to meet or exceed the requirements of current international standards.

The product range offers backwards compatibility with Category 5 systems, with enhanced performance.



PowerCat 5e U/UTP Cable

PowerCat Category 5e U/UTP 4 Pair cable has been designed to support high speed data transmission systems. The cable is available in PVC and LS0H sheaths on a 305m Reel-in-a-Box designed to facilitate transportation and cable access.

- U/UTP 4 pair PVC and LS0H cable
- Colour coded for ease of termination
- Independently tested
- 305 metre box
- Compliant with EN 50575:2014+A1:2016 EU Reaction to Fire Performance criteria

Order No.	SAP No.	Description
39.A0360	181770242	PowerCat 5e U/UTP, PVC Cable, Eca - Grey - 305m
39-504-5e	18170009	PowerCat 5e U/UTP LS0H Cable Dca-s2,d2,a1 Violet - 305m



PowerCat 5e UTP DataGate™ Jack

The DataGate Jack is the cornerstone of the Molex Premise Networks PowerCat 5e System performance.

This jack features a unique spring-loaded shutter that not only protects it from dust and contaminants, but the ingenious spring-loaded design also ejects improperly seated patch cords. The product is dual colour coded for either 568A or 568B wiring schedules.

- Dual Colour coding allows 568A/B wiring
- Patented IDC V-Shaped contacts that flex not fatigue when terminated
- Patented spring-loaded shutter
- RJ-11 compatible
- Accepts colour coded port identification labels
- Molex 4 Pair Termination Tool or industry standard 110 termination tool compatible

DataGate Shutter Operation

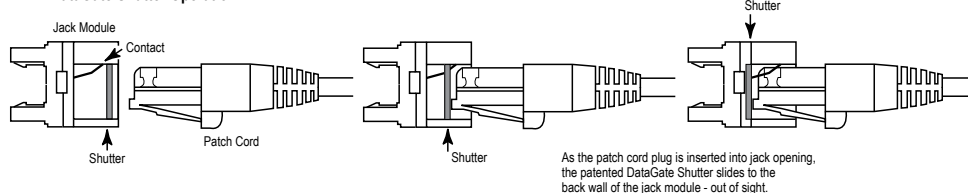

Order No.	SAP No.	Description
KSJ-00024-**	Consult Molex	PowerCat 5e DataGate Jack 8W 568A/B

** Colour Options - 01 = Almond, 02 = White, 04 = Black, 05 = Ivory, 08 = Light Grey, RD = Red, BL = Blue, GR = Green, YL = Yellow, RG = Orange, PP = Purple



Keystone Jack

Utilising patented IDC V-shaped contacts that flex not fatigue when terminated, the RJ-45 Keystone Jack is compatible with any product that accepts the standard keystone profile.

- Dual Colour coding allows 568A/B wiring
- Patented IDC V-Shaped contacts that flex not fatigue when terminated
- Features pointed IDC towers to speed termination and enhance cable retention
- RJ-11 & RJ-12 compatible
- Moulded category identification on jack face



Order No.	SAP No.	Description
KSJ-00032-**	Consult Molex	Keystone Jack, Category 5e, 8W, 568A/B

** Colour Options - 01 = Almond 02 = White 04 = Black

Copper Solutions PowerCat™ 5e UTP



PowerCat 5e DataGate™ Patch Panel

PowerCat 5e DataGate Panels feature the shuttered DataGate connector. These panels come with integral rear cable management trays and are available in 24 and 48 port versions. Individual ports can be colour coded using an icon for site-specific network administration.

- 19" Shuttered DataGate Category 5e Panel
- EIA 568A/B colour coded
- Integral cable management tray
- Graphite grey finish

Order No.	SAP No.	Description
PID-00174	182080372	PowerCat 5e 24 Port DataGate Patch Panel RJ45 568A/B UTP - 1U
PID-00175	0182080374	PowerCat 5e 48 Port DataGate Patch Panel RJ45 568A/B UTP - 2U



PowerCat Unloaded DataGate Panels

The Molex PowerCat Unloaded DataGate Patch Panels can be configured to provide the exact number of modular ports required. DataGate Category 5e UTP, Category 6 UTP, or Category 6A shielded jacks can be terminated to cable and then snapped into this DataGate patch panel. The patch panel and rear cable manager are constructed of cold-rolled steel for strength and durability.

- Available in 1U 24P Flat, 1U 24P Angled, 2U 48P Flat, 2U 48P Angled
- Easy snap in DataGate UTP or Shielded Jacks (sold separately)
- Modularity provides installation flexibility
- Front portable labelling
- Individually removable patch panel ports
- Removable cable management shelf ensures bend radius compliance
- ANSI and metric hardware kit included
- Grounding screws included

Order No.	SAP No.	Description
PID-00258	180810031	PowerCat 24 Port DataGate Patch Panel, Unloaded UTP or Shielded - 1U
PID-00259	180810032	PowerCat 24 Port DataGate Angled Patch Panel, Unloaded UTP or Shielded - 1U
PID-00260	180810033	PowerCat 48 Port DataGate Patch Panel, Unloaded UTP or Shielded - 2U
PID-00261	180810034	PowerCat 48 Port DataGate Angled Patch Panel, Unloaded UTP or Shielded - 2U
KSJ-00005-0*	Consult Molex	Single Position Blank Module (Bag of 25)

* Colour Options - 1 = Almond, 2 = White, 5 = Ivory, 4 = Black, 8 = Light Grey



PowerCat Standard Grade Patch Panels

PowerCat Standard Grade Patch Panels are a cost effective and versatile means for connecting horizontal cabling. Featuring an integral rear cable management tray for ease of installation and cable dressing. Port labelling is also featured for site-specific network administration.

- 24 Ports 1U
- PCB mounted KATT IDC
- EIA 568B wired
- Standard 19" rack mounted
- Integral cable management tray
- Graphite grey finish



Order No.	SAP No.	Description
PID-00058	181530012	PowerCat 5e 24 Port Patch Panel RJ45 568B UTP - 1U

Copper Solutions PowerCat™ 5e UTP



Modular Keystone Patch Panel

The Molex 24 Port Modular Keystone Jack patch panel is a flexible patching solution for small to medium size installations. The panel is shipped unloaded and can be configured to provide the exact number of ports required. The Keystone Jacks snap in easily and can be removed if required.

The patch panel features an integral rear cable management tray for ease of installation and cable dressing.

- Available in 24 Ports 1U
- Modularity provides installation flexibility
- Easy snap in Keystone Jacks
- Rear cable management included

Order No.	SAP No.	Description
PID-00257	182960014	Keystone Patch Panel, 24 Port, Unloaded - 1U
KSJ-00064-**	Consult Molex	Keystone Blank

**Standard Stocked Colours - 02 = White, 04 = Black.

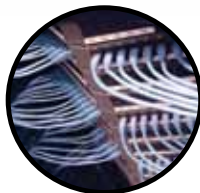

PowerCat Angled Patch Panels

Angled Patch Panels are ideal for installations of high density or which utilise extensive side and end-of-the-rack cable management. The angled feature provides enhanced port access and minimises patch cord bend radius to the rack. Each port features a patented spring-loaded shutter and can be colour coded to match jack outlets and provides both front and rear labelling options.

- Angled design
- Shuttered DataGate RJ45
- 24 Ports 1U & 48 Port 2U
- Category 5e performance
- EIA 568A/B wired
- Standard 19" rack mount
- Individually removable patch panel ports
- Integral cable management tray



Order No.	SAP No.	Description
PID-00154	0182020245	PowerCat 5e 24 Port Angled Patch Panel RJ45 568A/B UTP - 1U
PID-00155	0182080295	PowerCat 5e 48 Port Angled Patch Panel RJ45 568A/B UTP - 2U



PowerCat UTP High Density Patch Panel

The PowerCat High Density Patch Panel is ideal for installations where cabinet/rack space is at a premium. Providing 48 ports in 1U, this patch panel offers an integral rear cable management tray specifically designed for neat and easy cable dressing. The front of the panel has a clear port labelling facility for site-specific network administration.

- PowerCat (Category 5e) performance
- 48 Ports 1U
- PCB mounted KATT IDC
- EIA 568B wired
- Standard 19" rack mounted
- Integral cable management tray
- Graphite grey finish

Order No.	SAP No.	Description
PID-00073	0181820012	PowerCat 5e 48 Port High Density Patch Panel RJ45 56B UTP - 1U

Copper Solutions PowerCat™ 5e UTP



PowerCat UTP Synergy™ Surface Boxes

Synergy Surface boxes are ideal for use in open office environments. This product family comprises of 1, 2, 4 and 6 port variants offering simple, organised installation in areas where surface mount is the only option. Cable can be installed from the sides or base of the box.

- Simple, organised cable entry and installation
- Screw fixing
- Clear and concise labelling
- 568A/B wired
- DataGate Jacks included

Order No.	SAP No.	Description
SBX-00006-02	Consult Molex	PowerCat 5e 1 Port Synergy Surface Box RJ45 568A/B UTP - White
SSY-00010-02	181770327	PowerCat 5e 2 Port Synergy Surface Box RJ45 568A/B UTP - White
SSY-00011-02	181770328	PowerCat 5e 4 Port Synergy Surface Box RJ45 568A/B UTP - White
SSY-00012-02	181770329	PowerCat 5e 6 Port Synergy Surface Box RJ45 568A/B UTP - White



PowerCat UTP MOD-SNAP™ Modules

The PowerCat MOD-SNAP modular system provides a flexible and versatile method of installation, allowing the user the choice of installing as many data outlets as required. Providing a fascia size of 38.5 x 25mm (BT6C) MOD-SNAP modules are ideal for floorbox applications.

The Molex Category 5e RJLP RJ45 connector offers a low profile, space saving design that enables easy installation in shallow backboxes and trunking.

- Fascia size 38.5 x 25mm (BT6C)
- Cut out dimension 37.5 x 22mm
- Category 5e RJ45 RJLP connector
- Space saving low profile design enables installation in shallow backboxes and trunking
- Spring-loaded shutter
- Protected labelling facility
- Compatible with MOD-SNAP wallplates
- Ideal for floorbox applications



Order No.	SAP No.	Description
42.1B.011.A003*	0182080061	PowerCat 5e MOD-SNAP RJLP Module RJ45 568B UTP - White
MMS-00014-0*	181170009	MOD-SNAP Module Blank - White

** Colour Options - 2 = White 4 = Black

Fixed Wallplates

Fixed wallplates are ideal for space-limited areas such as power-poles and desk-top trunking, or areas where an unchanging number of ports are to be installed and modularity is not required.

The wallplates are a complete assembly and include the patented RJLP RJ45 connector, offering a low profile, space saving design that enables installation in shallow backboxes and trunking.

- UK standard 86 x 86mm fascia
- Category 5e RJ45 RJLP connector
- Spring-loaded shutters
- 1, 2 and 4 port options available
- EIA 568B wired



Order No.	SAP No.	Description
WNC-00007-02	0182080074	PowerCat 5e 1 Port Fixed Shuttered Wallplate RJ45 568B UTP - White
WNC-00008-02	0182080046	PowerCat 5e 2 Port Fixed Shuttered Wallplate RJ45 568B UTP - White
WNC-00009-02	0182080127	PowerCat 5e 4 Port Fixed Shuttered Wallplate RJ45 568B UTP - White

Copper Solutions

PowerCat™ 5e UTP



PowerCat UTP Patch Cords

Molex PowerCat 5e U/UTP Patch Cords are key components of PowerCat 5e U/UTP End-to-End Solution. PowerCat Patch Cords were designed to support data networks for 10/100BASE-T and 1000BASE-T applications. The patch cable is made from high quality four pair 24 AWG stranded copper wire. Available in a range of colours and lengths, PowerCat 5e patch cords are pre-terminated with RJ45 plugs and feature anti-slag slim strain relief slip on boots.

- 4 pair 24 AWG stranded wire
- Pre-terminated with WE8W plugs
- Slim clear anti-slag slip on boots
- Suitable for EIA 568A or 568B wiring applications
- LS0H sheath
- RoHS Compliant

Order No.	SAP No.	Description
PCD-01000-**	Consult Molex	PowerCat 5e U/UTP Patch Cord LS0H - 0.5m
PCD-01001-**	Consult Molex	PowerCat 5e U/UTP Patch Cord LS0H - 1m
PCD-01002-**	Consult Molex	PowerCat 5e U/UTP Patch Cord LS0H - 1.5m
PCD-01003-**	Consult Molex	PowerCat 5e U/UTP Patch Cord LS0H - 2m
PCD-01005-**	Consult Molex	PowerCat 5e U/UTP Patch Cord LS0H - 3m
PCD-01009-**	Consult Molex	PowerCat 5e U/UTP Patch Cord LS0H - 5m
PCD-01013-**	Consult Molex	PowerCat 5e U/UTP Patch Cord LS0H - 7m
PCD-01019-**	Consult Molex	PowerCat 5e U/UTP Patch Cord LS0H - 10m

** Colour Options - 0C = Red, 0E = Grey, 0H = Blue, 0J = Green, 0K = Yellow, 0W = White, 0P = Purple, 0N = Orange, BK = Black
 Standard Stocked Colours - Grey, Red, Blue. All other colours and lengths may be subject to MOQ's, longer lead times and variable pricing.
 Standard Stocked Lengths - 1, 2, 3, 5, 7, 10 metres

Copper Solutions PowerCat™ 5e Shielded

Molex's Category 5e Shielded product range, PowerCat™, is designed to meet or exceed requirements of all current international standards.

The product range offers backwards compatibility with Category 5 systems, with enhanced performance.



PowerCat Shielded Patch Panel

The 24 Port Shielded Patch Panel offers through-shield continuity and is a versatile method of connecting horizontal cabling in a shielded environment.

- 24 Port 1U
- 568A/B wired
- Integral rear cable management
- Port identification
- 19" rack mounted
- Graphite Grey finish

Order No.	SAP No.	Description
PID-00030	181430008	PowerCat 5e 24 Port Patch Panel with Cover 568A/B Shielded - 1U



PowerCat F/UTP Cable

PowerCat F/UTP 4 pair cable with overall shield and drain-wire is available in PVC, LS0H IEC 332.1 variants. Available in 305m boxes.

- 4 pair PVC or LS0H Cable
- Colour coded pairs for ease of termination
- 305m easy spool box
- Compliant with EN50575:2014+A1:2016 EU reaction to Fire Performance criteria

Order No.	SAP No.	Description
39A-504-FT	Consult Molex	PowerCat 5e F/UTP PVC Cable Eca- Yellow - 305m
39A-504-LS	Consult Molex	PowerCat 5e F/UTP LS0H Cable Dca-s2,d2.a1 Violet 305m



PowerCat Shielded Euromod™ Modules

The PowerCat Euromod modular system provides a flexible and versatile method of installation. This modular system offers a range of wallplates and modules that allow the user to install as many data outlets as required. The modules are fully assembled units featuring the low profile Category 5e RJLP connector and a 25 x 50mm fascia, shutter and spring assembly.

- Enhanced performance RJ45 RJLP connector
- Space saving low profile design enables installation in shallow backboxes and trunking
- Spring-loaded shutter
- Compatible with Euromod wallplates
- EIA 568B wired

Molex's Category 5e RJLP RJ45 connector offers a low profile, space saving design that enables installation in shallow backboxes and trunking. The shielded connector provides continuity of the cable shield by providing a termination point for the drain wire.

Order No.	SAP No.	Description
MEU-00020-02	0181900002	Euromod RJLP Module RJ45 568B FTP Category 5e - White



Copper Solutions

PowerCat™ 5e Shielded



PowerCat Shielded MOD-SNAP™ Module

The PowerCat MOD-SNAP modular system provides a flexible and versatile method of installation, allowing the user the choice of installing as many data outlets as required. The modules are fully assembled units featuring the low profile Category 5e RJ45 RJLP connector, a 38.5 x 25mm fascia (BT6C size), shutter and spring assembly.

Molex's Category 5e RJLP RJ45 connector offers a low profile, space saving design that enables installation in shallow backboxes and trunking. The shielded connector provides continuity of the cable shield by providing a termination point for the drain wire.

- Category 5e RJ45 RJLP connector
- Space saving low profile design enables installation in shallow backboxes and trunking
- Spring-loaded shutter
- Protected labelling facility
- Compatible with MOD-SNAP wallplates
- Ideal for floorbox applications
- EIA 568B wired

Order No.	SAP No.	Description
MMS-00004-**	182160000	MOD-SNAP RJLP Module RJ45 568B FTP Category 5e - White

** Colour Options - 02 = White 04 = Black

Tomorrow's innovations Simply Solved >



Fibre has been an integral medium for structured cabling systems for many years. Used traditionally in the backbone – fibre is now becoming more prevalent in high speed networks by virtue of its bandwidth capabilities, size and the security it offers over and above copper media.



Fibre Optic Solutions

Product offering

Molex manufactures some of the most comprehensive fibre systems in the structured cabling market, incorporating a variety of connector technologies, such as; ST®, Duplex SC and LC. Molex offers total fibre solutions, ideal for either Backbone or To-The-Desk applications.

The Molex Fibre product range consists of Management Panels, Enclosures, Adapter Plates, Connectors, Modules, Cable, Pre-Terminated Solutions, Adapters, Patch Cords, Splicing Equipment, Field Termination Connectors, Tool Kits and Testers.

Patch Cords

Molex's advanced manufacturing process provides exceptional performance in patch cord assemblies. Molex maintains strict control over the ferrule endface surface. With the aid of an interferometer, the ferrule endface geometry is measured for radius, concentricity and apex offset, ensuring high performance and long-term reliability of all terminations.

Adapters & Connectors

Molex manufactures a full line of high performance fibre adapters and connectors. Designed with the latest engineering polymer and ceramic materials, all fibre adapters and connectors have been tested to and meet all the rigorous Telecommunication, CATV and Data communication industry standards.



Fibre Optic Solution Lightband™ Cable



Fibre Cable - Internal/External Tight Buffered

Molex Fibre Cable is available in multiple cores. Using tight buffered 9/125µm, 50/125µm and 62/125µm distribution grade fibre that either meets or exceeds, OM1, OM2, OM3, OM4, OS1 and OS2 standards. The outer jacket is LS0H, compliant with EU Reaction to Fire regulation.

- Internal or dry/free draining duct installation
- "E glass" yarn strength member
- 900µm secondary coated fibre
- All meet or exceed OS2 Singlemode, OM1, OM2, OM3 and OM4 Multimode standards
- LS0H sheaths
- Compliant with EN 50575:2014+A1:2016 EU Reaction to Fire Performance criteria

Order No	SAP No.	Fibre Type	No. of Cores	Sheath Colour	EuroClass
CFR-00373	0180580441	OM2	4	Green	Eca
CFR-00374	0180580441	OM2	6	Green	Eca
CFR-00375	0180580441	OM2	8	Green	Eca
CFR-00376	0180580441	OM2	12	Green	Eca
CFR-00378	0180580445	OM2	24	Green	Eca
CFR-00687	183280004	OM3	4	Aqua	Bca-s1a,d1,a1
CFR-00688	183280005	OM3	6	Aqua	Bca-s1a,d1,a1
CFR-00689	183280006	OM3	8	Aqua	Bca-s1a,d1,a1
CFR-00690	183280007	OM3	12	Aqua	Bca-s1a,d1,a1
CFR-00691	183280008	OM3	24	Aqua	Bca-s1a,d1,a1
CFR-00493	180580677	OM3	4	Aqua	Cca-s1a,d1,a1
CFR-00494	180580678	OM3	6	Aqua	Cca-s1a,d1,a1
CFR-00495	180580679	OM3	8	Aqua	Cca-s1a,d1,a1
CFR-00496	180580523	OM3	12	Aqua	Cca-s1a,d1,a1
CFR-00497	180580640	OM3	24	Aqua	Cca-s1a,d1,a1
CFR-00380	180580449	OM3	4	Green	Eca
CFR-00381	180580451	OM3	6	Green	Eca
CFR-00382	180580453	OM3	8	Green	Eca
CFR-00383	180580454	OM3	12	Green	Eca
CFR-00384	180580455	OM3	24	Green	Eca
CFR-00692	183280009	OM4	4	Erika Violet	Bca-s1a,d1,a1
CFR-00693	183280010	OM4	6	Erika Violet	Bca-s1a,d1,a1
CFR-00694	183280011	OM4	8	Erika Violet	Bca-s1a,d1,a1
CFR-00695	183280012	OM4	12	Erika Violet	Bca-s1a,d1,a1
CFR-00696	183280013	OM4	24	Erika Violet	Bca-s1a,d1,a1
CFR-00622	180580684	OM4	4	Erika Violet	Cca-s1a,d1,a1
CFR-00623	180580685	OM4	6	Erika Violet	Cca-s1a,d1,a1
CFR-00624	180580686	OM4	8	Erika Violet	Cca-s1a,d1,a1
CFR-00625	183280003	OM4	12	Erika Violet	Cca-s1a,d1,a1
CFR-00626	180580687	OM4	24	Erika Violet	Cca-s1a,d1,a1
CFR-00584	0180580370	OM4	4	Green	Eca
CFR-00585	0180580371	OM4	6	Green	Eca
CFR-00586	0180580372	OM4	8	Green	Eca
CFR-00587	0180580373	OM4	12	Green	Eca
CFR-00589	0180580375	OM4	24	Green	Eca

Fibre Optic Solution Lightband™ Cable



Fibre Cable - Internal/External Tight Buffered

Molex Fibre Cable is available in multiple cores. Using tight buffered 9/125µm, 50/125µm and 62/125µm distribution grade fibre that either meets or exceeds, OM1, OM2, OM3, OM4, OS1 and OS2 standards. The outer jacket is LS0H, compliant the with EU Reaction to Fire regulation.

- Internal or dry/free draining duct installation
- "E glass" yarn strength member
- 900µm secondary coated fibre
- All meet or exceed OS2 Singlemode, OM1, OM2, OM3 and OM4 Multimode standards
- LS0H sheaths
- Compliant with EN 50575:2014+A1:2016 EU Reaction to Fire Performance criteria

Order No	SAP No.	Fibre Type	No. of Cores	Sheath Colour	EuroClass
CFR-00697	183280014	OS2	4	Yellow	Bca-s1a,d1,a1
CFR-00698	183280015	OS2	6	Yellow	Bca-s1a,d1,a1
CFR-00699	183280016	OS2	8	Yellow	Bca-s1a,d1,a1
CFR-00700	183280017	OS2	12	Yellow	Bca-s1a,d1,a1
CFR-00701	183280018	OS2	24	Yellow	Bca-s1a,d1,a1
CFR-00498	180580680	OS2	4	Yellow	Cca-s1a,d1,a1
CFR-00499	180580678	OS2	6	Yellow	Cca-s1a,d1,a1
CFR-00500	180580682	OS2	8	Yellow	Cca-s1a,d1,a1
CFR-00501	180580285	OS2	12	Yellow	Cca-s1a,d1,a1
CFR-00502	180580683	OS2	24	Yellow	Cca-s1a,d1,a1
CFR-00387	0180580464	OS2	4	Green	Eca
CFR-00388	0180580466	OS2	6	Green	Eca
CFR-00389	0180580468	OS2	8	Green	Eca
CFR-00390	0180580469	OS2	12	Green	Eca
CFR-00392	0180580471	OS2	24	Green	Eca



Fibre Cable - Multi-Purpose Loose Tube

Molex multi-purpose fibre optic loose tube cable is suitable for LAN backbones, telecom access lines and campus backbones. The cable is a gel filled central loose tube design with swellable glass yarns as a strength member and rodent protection. The outer jacket is LS0H, compliant the with EU Reaction to Fire regulation material.

- Loose tube
- Gel filled
- Glass strength member
- Compliant with EN 50575:2014+A1:2016 EU Reaction to Fire Performance criteria

Order No	SAP No.	Fibre Type	No. of Cores	Sheath Colour	EuroClass
CFR-00569	0180580481	OM2	4	Blue	Eca
CFR-00570	0180580482	OM2	6	Blue	Eca
CFR-00571	0180580483	OM2	8	Blue	Eca
CFR-00572	0180580484	OM2	12	Blue	Eca
CFR-00573	0180580485	OM2	24	Blue	Eca
CFR-00672	183150055	OM3	4	Aqua	Bca-s1a,d1,a1
CFR-00673	183150056	OM3	6	Aqua	Bca-s1a,d1,a1
CFR-00674	183150057	OM3	8	Aqua	Bca-s1a,d1,a1
CFR-00675	183150058	OM3	12	Aqua	Bca-s1a,d1,a1
CFR-00676	183150059	OM3	24	Aqua	Bca-s1a,d1,a1

Fibre Optic Solution Lightband™ Cable



Fibre Cable - Multi-Purpose Loose Tube

Molex multi-purpose fibre optic loose tube cable is suitable for LAN backbones, telecom access lines and campus backbones. The cable is a gel filled central loose tube design with swellable glass yarns as a strength member and rodent protection. The outer jacket is LSOH, compliant with EU Reaction to Fire regulation material.

- Loose tube
- Gel filled
- Glass strength member
- Compliant with EN 50575:2014+A1:2016 EU Reaction to Fire Performance criteria

Order No	SAP No.	Fibre Type	No. of Cores	Sheath Colour	EuroClass
CFR-00657	183150040	OM3	4	Aqua	Dca-s2-d2,a1
CFR-00658	183150041	OM3	6	Aqua	Dca-s2-d2,a1
CFR-00659	183150042	OM3	8	Aqua	Dca-s2-d2,a1
CFR-00660	183150043	OM3	12	Aqua	Dca-s2-d2,a1
CFR-00661	183150044	OM3	24	Aqua	Dca-s2-d2,a1
CFR-00574	0180580486	OM3	4	Blue	Eca
CFR-00575	0180580487	OM3	6	Blue	Eca
CFR-00576	0180580488	OM3	8	Blue	Eca
CFR-00577	0180580489	OM3	12	Blue	Eca
CFR-00578	0180580491	OM3	24	Blue	Eca
CFR-00677	183150060	OM4	4	Erika Violet	Bca-s1a,d1,a1
CFR-00678	183150061	OM4	6	Erika Violet	Bca-s1a,d1,a1
CFR-00679	183150062	OM4	8	Erika Violet	Bca-s1a,d1,a1
CFR-00680	183150063	OM4	12	Erika Violet	Bca-s1a,d1,a1
CFR-00681	183150064	OM4	24	Erika Violet	Bca-s1a,d1,a1
CFR-00662	183150045	OM4	4	Erika Violet	Dca-s2-d2,a1
CFR-00663	183150046	OM4	6	Erika Violet	Dca-s2-d2,a1
CFR-00664	183150047	OM4	8	Erika Violet	Dca-s2-d2,a1
CFR-00665	183150048	OM4	12	Erika Violet	Dca-s2-d2,a1
CFR-00666	183150049	OM4	24	Erika Violet	Dca-s2-d2,a1
CFR-00594	0180580492	OM4	4	Blue	Eca
CFR-00595	0180580493	OM4	6	Blue	Eca
CFR-00596	0180580494	OM4	8	Blue	Eca
CFR-00597	0180580495	OM4	12	Blue	Eca
CFR-00598	0180580496	OM4	24	Blue	Eca
CFR-00682	183150065	OS2	4	Yellow	Bca-s1a,d1,a1
CFR-00683	183150066	OS2	6	Yellow	Bca-s1a,d1,a1
CFR-00684	183150067	OS2	8	Yellow	Bca-s1a,d1,a1
CFR-00685	183150068	OS2	12	Yellow	Bca-s1a,d1,a1
CFR-00686	183150069	OS2	24	Yellow	Bca-s1a,d1,a1
CFR-00667	183150050	OS2	4	Yellow	Dca-s2-d2,a1
CFR-00668	183150051	OS2	6	Yellow	Dca-s2-d2,a1
CFR-00669	183150052	OS2	8	Yellow	Dca-s2-d2,a1
CFR-00670	183150053	OS2	12	Yellow	Dca-s2-d2,a1
CFR-00671	183150054	OS2	24	Yellow	Dca-s2-d2,a1
CFR-00579	0180580497	OS2	4	Blue	Eca
CFR-00580	0180580498	OS2	6	Blue	Eca
CFR-00581	0180580499	OS2	8	Blue	Eca
CFR-00582	0180580500	OS2	12	Blue	Eca
CFR-00583	0180580501	OS2	24	Blue	Eca

Fibre Optic Solution Lightband™ Cable



Fibre Cable - Direct Burial Armoured Loose Tube

Molex Loose Tube Armoured Fibre Cable is constructed of gel filled loose tubes (4-12 fibres). The core is water blocked, wrapped in polyester tape with an inner and outer MDPE sheath. Corrugated steel armouring makes the cable rodent resistant. The cable is designed for direct burial, outdoor data communication applications.

- Outdoor direct burial
- Corrugated steel armoured
- Rodent resistant
- Gel filled loose tube construction
- Compliant with EN 50575:2014+A1:2016 EU Reaction to Fire Performance criteria:Fca

OM2 (50/125)	SAP No.	No. of Cores
CFR-00544	Consult Molex	4
CFR-00545	Consult Molex	6
CFR-00546	Consult Molex	8
CFR-00547	Consult Molex	12
CFR-00548	Consult Molex	16
CFR-00549	Consult Molex	24

OM3 (50/125)	SAP No.	OS1 & 2 (9/125)	SAP No.	No. of Cores
CFR-00551	Consult Molex	CFR-00558	Consult Molex	4
CFR-00552	Consult Molex	CFR-00559	Consult Molex	6
CFR-00553	Consult Molex	CFR-00560	Consult Molex	8
CFR-00554	Consult Molex	CFR-00561	Consult Molex	12
CFR-00555	Consult Molex	CFR-00562	Consult Molex	16
CFR-00556	Consult Molex	CFR-00563	Consult Molex	24

Note: OM4 Available on request subject to MOQ's, please contact internal sales for more information and SAP numbers.

Fibre Optic Solution Lightband™ Pre-Terminated Fibre Trunk Assemblies



Molex Pre-Terminated Fibre Optic Leads offer premium factory-controlled optical performance on a variety of connectors that enable fast, economical installation.

Pre-Terminated Leads are ideal for mission-critical backbone applications such as Data Centre tie cables and low optical loss backbone riser cables.

Pre-terminated Fibre Optic Leads

- Available in 50/125µm and 62.5/125µm MM and 9/125µm SM fibre versions
- Fibres compliant to ISO/IEC 11801 fibre specifications
- Wide variety of connector and cable types offered
- Cable length built to customer requirements

- Premium factory optical performance guaranteed
- RoHS compliant
- All assemblies are 100% factory tested - factory test results shipped with every assembly

ORDERING INFORMATION

Part No. Matrix - Substitute the correct code number or letter to determine the assembly construction

9 1 X X X X X X X X X X X X X X X X

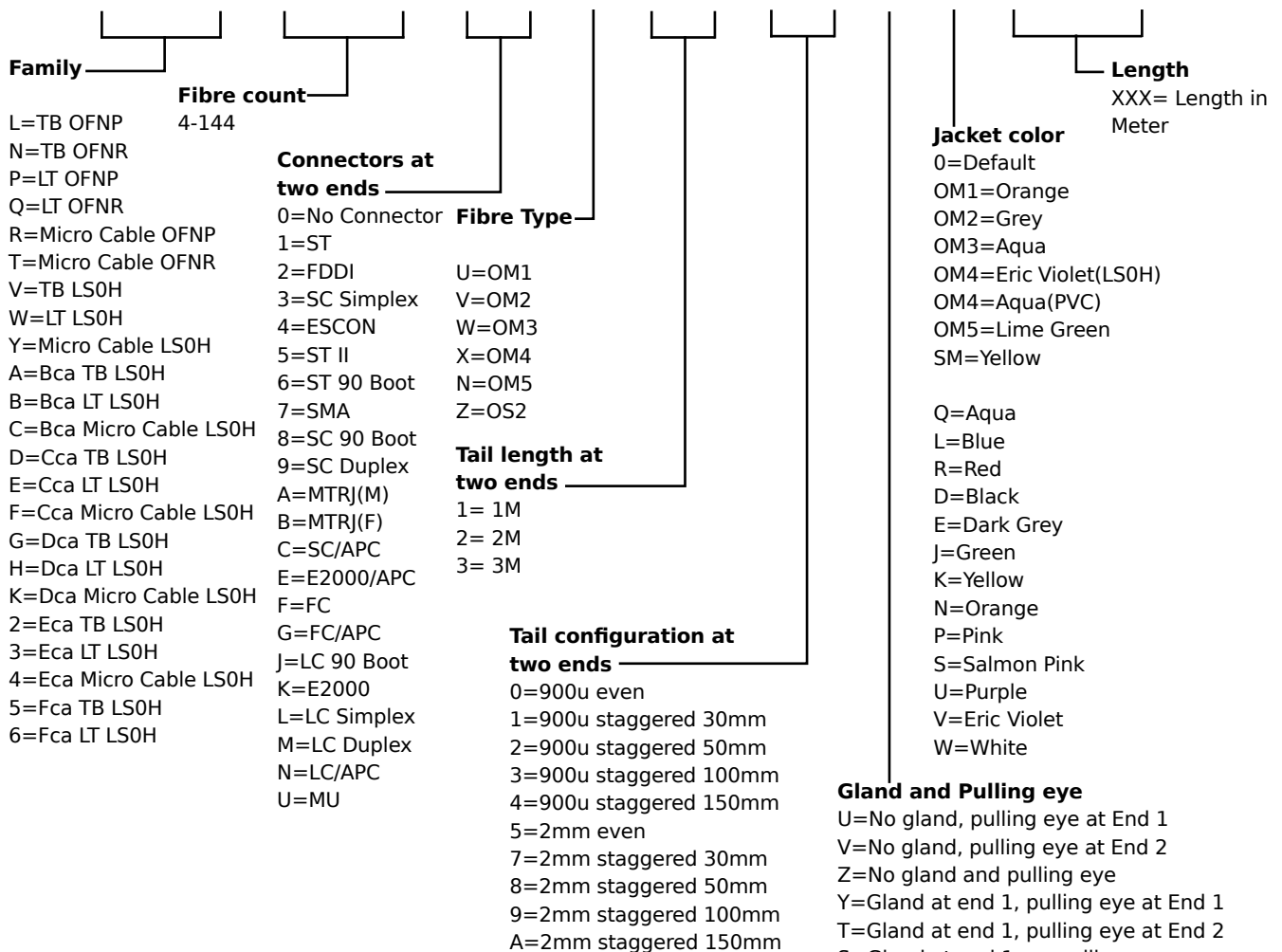

* Micro-core cable only for 48 and above cores numbers

Fiber Optic Solution

Lightband™

Patch Cords



Fibre Optic Patch Cords

- Available in 50/125µm and 62.5/125µm MM and 9/125µm SM fibre versions
 - Fibres compliant to ISO/IEC 11801 fibre specifications
 - Standard or custom assemblies
 - Precision ferrule endface geometry
 - Wide variety of connector and cable types offered
- Controlled fibre protrusion
 - Factory polished, tested and serialised
 - RoHS Compliant
 - Insertion Loss -
Singlemode: <0.35 dB per connector
Multimode: <0.5 dB per connector

Part No. Matrix - Substitute the correct code number or letter to determine the assembly instruction

9 1 . X X . X X X . X X X X X - X

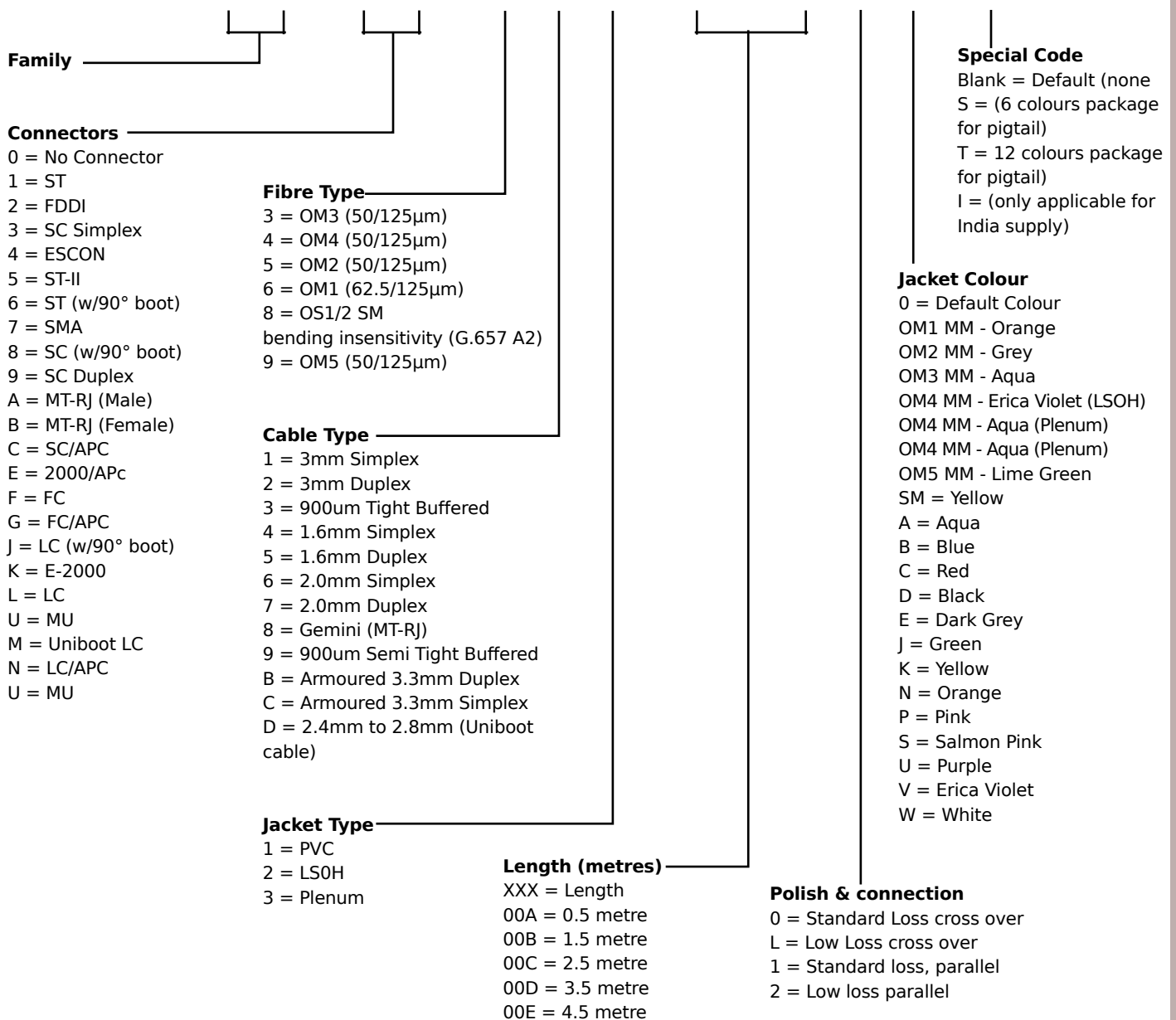

For Example: To order a 1 metre DLC - DSC OM3 Patch Cord the part number would be 91.9L.372.00100

Fibre Optic Solution Lightband™ Patch Cords & Pigtails



Fibre Pigtails

Molex offers a comprehensive range of fibre optic pigtails for Singlemode and Multimode applications. Fibre Pigtails are available as standard in 1m lengths.

- Ruggedised cable construction
- Insertion loss better than 0.35 dB
- All meet or exceed OM1, OM2 and OM3 Multimode and OS1 Singlemode standards

OM2 (50/125)	SAP No.	Description
91.10.532.00100	180610081	ST Pigtail, LS0H - 1m
91.30.532.00100	180610091	SC Pigtail, LS0H - 1m
91.L0.532.00100	180610092	LC Pigtail, LS0H - 1m

OM3 (50/125)	SAP No.	Description
91.10.332.00100	180610082	ST Pigtail, LS0H - 1m
91.30.332.00100	180610093	SC Pigtail, LS0H - 1m
91.L0.332.00100	180610094	LC Pigtail, LS0H - 1m

OM4 (50/125)	SAP No.	Description
91.10.432.00100	Consult Molex	ST Pigtail, LS0H - 1m
91.30.432.00100	Consult Molex	SC Pigtail, LS0H - 1m
91.L0.432.00100	Consult Molex	LC Pigtail, LS0H - 1m

OS2 (9/125)	SAP No.	Description
91.10.832.00100	180610080	ST Pigtail, LS0H - 1m
91.30.832.00100	180610095	SC Pigtail, LS0H - 1m
91.L0.832.00100	180610096	LC Pigtail, LS0H - 1m

Optical Fibre Solution Lightband™ Uniboot LC



Uniboot LC Low Loss Patch Cords

The Uniboot LC Low Loss Patch Cords are slim-line patch cords, ideal for high density/high speed applications. Using a uniboot patch cord provides a 50% space saving when compared to traditional optical patch cords.

Ideal for Data Centre, SAN, Enterprise/Campus and Telco central office applications.

- Full Duplex in a single 3mm cable
- Available in Low Loss OM3, OM4 and OS1/2 Fibre Types
- Reduces space required in cable ways and racks improving access and HVAC performance
- LS0H sheath

Order No.	SAP No.	Description
91.MM.372.YYYL0	Consult Molex	Optical Fibre Patch Cords, LC Uniboot-LC Uniboot, Multimode OM3, Low Loss, LS0H - Aqua
91.MM.472.YYYL0	Consult Molex	Optical Fibre Patch Cords, LC Uniboot-LC Uniboot, Multimode OM4, Low Loss, LS0H - Erika Violet
91.MM.872.YYYL0	Consult Molex	Optical Fibre Patch Cords, LC Uniboot-LC Uniboot, Singlemode OS1/2, Low Loss, LS0H - Yellow
91.3M.372.YYYL0	Consult Molex	Optical Fibre Patch Cords, LC Uniboot-LC Uniboot, Multimode OM3, Low Loss, LS0H - Aqua

Note: Cable length can be customised. Insert required length in place of the YYY in the part number.

Optical Fibre Solution Lightband™ Rack Mount Solutions



RFR-00311-BK



RFR-00312-BK



RFR-00311-BK loaded with AFR-00534-AQ

1U Multi-Function Fibre Enclosure Gen II

The 1U Multi-Function Fibre Enclosure is a configurable rack mount unit for storing and terminating incoming fibre cable. The fibre enclosure has been designed to accommodate various termination types and adapter configurations. The floor of the enclosure is constructed to allow maximum flexibility in routing fibres. Constructed with a ball bearing slide mechanism allows ease of access to fibres. The interchangeable front plate facilitates upgrades as required. The enclosure has an optional front locking kit and an optional front cable management to securely route patch cords.

- Accommodates up to 4 ModLink Quick Connect Cassettes which allows 12-24 fibre connections per cassette with various interfacing adapters
- Accommodates up to 4 Modular Splice Cassettes, which allows 6-24 fibre connections per cassette. The splice cassettes allow for splice termination while protecting individual fibres
- Compatible with preloaded adapter plates in various fibre counts and adapter configurations
- Self-Adhesive fibre management hub is stackable and can be segmented providing individualisation of fibre routing
- Optional 24 fibre splice tray available to maximise port capacity while providing fibre management for excess fibre
- Optional front cable management allows for secure routing of patch cords and can be retrofitted
- Optional locking kits provide security
- Compatible with Molex's 6 Fibre Adapter plates that allow 6-24 fibre connections per plate, 72 Fibre MTP connections and 3 x DataGate Copper/Synergy connections per plate
- Rugged steel construction in graphite finish
- Compatible with Molex 3 x DataGate Jack UTP or C6A Adapter Plate for Multimedia applications

Order No.	SAP No.	Description
RFR-00311-BK	180370287	1U Multi-Function Fibre Enclosure Gen II
Optional Enhancements		
RFR-00312-BK	180370288	Locking Front Assembly Kit
CMA-00111	181050048	Front Cable Manager
AFR-00468-04	180600394	6 Pak Adapter Front Plate
AFR-00469-04	180600395	Full Length Blanking Plate

Adapter Plates (Loaded)



Order No.	SAP No.	Description
AFR-00598-BL	180600392	SC Simplex, 24 Fibre Adapter Plate, Unshuttered, SM - Blue
AFR-00599-GR	180600393	SC/APC Simplex, 24 Fibre Adapter Plate, Unshuttered, SM - Green
AFR-00600-0L	180600402	SC Simplex, 24 Fibre Adapter Plate, Unshuttered, MM - Beige
AFR-00601-AQ	180600403	SC Simplex, 24 Fibre Adapter Plate, Unshuttered, MM - Aqua
AFR-00602-EV	180600404	SC Simplex, 24 Fibre Adapter Plate, Unshuttered, MM - Erica Violet
AFR-00603-BL	180600405	LC Duplex, 48 Fibre Adapter Plate, Unshuttered, SM - Blue
AFR-00604-GR	180600406	LC/APC Duplex, 48 Fibre Adapter Plate, Unshuttered, SM - Green
AFR-00605-0L	180600407	LC Duplex, 48 Fibre Adapter Plate, Unshuttered, MM - Beige
AFR-00606-AQ	180600408	LC Duplex, 48 Fibre Adapter Plate, Unshuttered, MM - Aqua
AFR-00607-EV	180600409	LC Duplex, 48 Fibre Adapter Plate, Unshuttered, MM - Erica Violet
AFR-00608-BL	180600410	SC Simplex, 48 Fibre Adapter Plate, Unshuttered, SM - Blue
AFR-00609-GR	180600411	SC/APC Simplex, 48 Fibre Adapter Plate, Unshuttered, SM - Green
AFR-00610-0L	180600412	SC Simplex, 48 Fibre Adapter Plate, Unshuttered, MM - Beige
AFR-00611-AQ	180600413	SC Simplex, 48 Fibre Adapter Plate, Unshuttered, MM - Aqua
AFR-00612-EV	180600414	SC Simplex, 48 Fibre Adapter Plate, Unshuttered, MM - Erica Violet
AFR-00613-BL	180600415	LC Quad, 96 Fibre Adapter Plate, Unshuttered, SM - Blue
AFR-00614-GR	180600416	LC/APC Quad, 96 Fibre Adapter Plate, Unshuttered, SM - Green
AFR-00615-0L	180600417	LC Quad, 96 Fibre Adapter Plate, Unshuttered, MM - Beige
AFR-00616-AQ	180600418	LC Quad, 96 Fibre Adapter Plate, Unshuttered, MM - Aqua
AFR-00617-EV	180600419	LC Quad, 96 Fibre Adapter Plate, Unshuttered, MM - Erica Violet
AFR-00618-BL	180600420	SC Duplex, 24 Fibre Adapter Plate, Unshuttered, SM - Blue
AFR-00619-GR	180600421	SC/APC Duplex, 24 Fibre Adapter Plate, Unshuttered, SM - Green
AFR-00620-0L	180600422	SC Duplex, 24 Fibre Adapter Plate, Unshuttered, MM - Beige
AFR-00621-AQ	180600423	SC Duplex, 24 Fibre Adapter Plate, Unshuttered, MM - Aqua
AFR-00622-EV	180600424	SC Duplex, 24 Fibre Adapter Plate, Unshuttered, MM - Erica Violet
AFR-00623-BL	180600425	LC Quad, 48 Fibre Adapter Plate, Unshuttered, SM - Blue

Optical Fibre Solution Lightband™ Rack Mount Solutions



Adapter Plates (Loaded) *continued*

AFR-00624-GR	180600426	LC/APC Quad, 48 Fibre Adapter Plate, Unshuttered, SM - Green
AFR-00625-OL	180600427	LC Quad, 48 Fibre Adapter Plate, Unshuttered, MM - Beige
AFR-00626-AQ	180600428	LC Quad, 48 Fibre Adapter Plate, Unshuttered, MM - Aqua
AFR-00627-EV	180600429	LC Quad, 48 Fibre Adapter Plate, Unshuttered, MM - Erica Violet
AFR-00464-04	180600430	FC Simplex 24 Fibre Adapter Plate, SM
AFR-00465-04	180600431	FC Simplex 24 Fibre Adapter Plate, MM
AFR-00467-04	180600432	ST Simplex 24 Fibre Adapter Plate, SM/MM
AFR-00628-BL	180600433	SC Duplex, 36 Fibre Adapter Plate, Unshuttered, SM - Blue
AFR-00629-GR	180600434	SC/APC Duplex, 36 Fibre Adapter Plate, Unshuttered, SM - Green
AFR-00630-OL	180600435	SC Duplex, 36 Fibre Adapter Plate, Unshuttered, MM - Beige
AFR-00631-AQ	180600436	SC Duplex, 36 Fibre Adapter Plate, Unshuttered, MM - Aqua
AFR-00632-EV	180600437	SC Duplex, 36 Fibre Adapter Plate, Unshuttered, MM - Erica Violet
AFR-00633-BL	180600438	SC Simplex, 6 Fibre Adapter Plate, Unshuttered, SM - Blue
AFR-00634-GR	180600439	SC/APC Simplex, 6 Fibre Adapter Plate, Unshuttered, SM - Green
AFR-00635-OL	180600440	SC Simplex, 6 Fibre Adapter Plate, Unshuttered, MM - Beige
AFR-00636-AQ	180600441	SC Simplex, 6 Fibre Adapter Plate, Unshuttered, MM - Aqua
AFR-00637-EV	180600442	SC Simplex, 6 Fibre Adapter Plate, Unshuttered, MM - Erica Violet
AFR-00638-BL	180600443	LC Duplex, 12 Fibre Adapter Plate, Unshuttered, SM - Blue
AFR-00639-GR	180600444	LC/APC Duplex, 12 Fibre Adapter Plate, Unshuttered, SM - Green
AFR-00640-OL	180600445	LC Duplex, 12 Fibre Adapter Plate, Unshuttered, MM - Beige
AFR-00641-AQ	180600446	LC Duplex, 12 Fibre Adapter Plate, Unshuttered, MM - Aqua
AFR-00642-EV	180600447	LC Duplex, 12 Fibre Adapter Plate, Unshuttered, MM - Erica Violet
AFR-00643-BL	180600448	SC Duplex, 12 Fibre Adapter Plate, Unshuttered, SM - Blue
AFR-00644-GR	180600449	SC/APC Duplex, 12 Fibre Adapter Plate, Unshuttered, SM - Green
AFR-00645-OL	180600450	SC Duplex, 12 Fibre Adapter Plate, Unshuttered, MM - Beige
AFR-00646-AQ	180600451	SC Duplex, 12 Fibre Adapter Plate, Unshuttered, MM - Aqua
AFR-00647-EV	180600452	SC Duplex, 12 Fibre Adapter Plate, Unshuttered, MM - Erica Violet
AFR-00648-BL	180600453	LC Quad, 24 Fibre Adapter Plate, Unshuttered, SM - Blue
AFR-00649-GR	180600454	LC/APC Quad, 24 Fibre Adapter Plate, Unshuttered, SM - Green
AFR-00650-OL	180600455	LC Quad, 24 Fibre Adapter Plate, Unshuttered, MM - Beige
AFR-00651-AQ	180600456	LC Quad, 24 Fibre Adapter Plate, Unshuttered, MM - Aqua
AFR-00652-EV	180600457	LC Quad, 24 Fibre Adapter Plate, Unshuttered, MM - Erica Violet
AFR-00728-BL	180600496	SC Simplex, 6 Fibre Adapter Plate, Shuttered, SM - Blue
AFR-00729-GR	180600497	SC/APC Simplex, 6 Fibre Adapter Plate, Shuttered, SM - Green
AFR-00730-OL	180600498	SC Simplex, 6 Fibre Adapter Plate, Shuttered, MM - Beige
AFR-00731-AQ	180600499	SC Simplex, 6 Fibre Adapter Plate, Shuttered, MM - Aqua
AFR-00732-EV	180600500	SC Simplex, 6 Fibre Adapter Plate, Shuttered, MM - Erica Violet
AFR-00733-BL	180600501	LC Duplex, 12 Fibre Adapter Plate, Shuttered, SM - Blue
AFR-00734-GR	180600502	LC/APC Duplex, 12 Fibre Adapter Plate, Shuttered, SM - Green
AFR-00735-OL	180600503	LC Duplex, 12 Fibre Adapter Plate, Shuttered, MM - Beige
AFR-00736-AQ	180600504	LC Duplex, 12 Fibre Adapter Plate, Shuttered, MM - Aqua
AFR-00737-EV	180600505	LC Duplex, 12 Fibre Adapter Plate, Shuttered, MM - Erica Violet
AFR-00738-BL	180600506	SC Duplex, 12 Fibre Adapter Plate, Shuttered, SM - Blue
AFR-00739-GR	180600507	SC/APC Duplex, 12 Fibre Adapter Plate, Shuttered, SM - Green
AFR-00740-OL	180600508	SC Duplex, 12 Fibre Adapter Plate, Shuttered, MM - Beige
AFR-00741-AQ	180600509	SC Duplex, 12 Fibre Adapter Plate, Shuttered, MM - Aqua
AFR-00742-EV	180600510	SC Duplex, 12 Fibre Adapter Plate, Shuttered, MM - Erica Violet
AFR-00743-BL	180600511	LC Duplex, 24 Fibre Adapter Plate, Shuttered, SM - Blue
AFR-00744-GR	180600512	LC/APC Duplex, 24 Fibre Adapter Plate, Shuttered, SM - Green
AFR-00745-OL	180600513	LC Duplex, 24 Fibre Adapter Plate, Shuttered, MM - Beige
AFR-00746-AQ	180600514	LC Duplex, 24 Fibre Adapter Plate, Shuttered, MM - Aqua
AFR-00747-EV	180600515	LC Duplex, 24 Fibre Adapter Plate, Shuttered, MM - Erica Violet
AFR-00748-BL	180600516	SC Duplex, 24 Fibre Adapter Plate, Shuttered, SM - Blue
AFR-00749-GR	180600517	SC/APC Duplex, 24 Fibre Adapter Plate, Shuttered, SM - Green
AFR-00750-OL	180600518	SC Duplex, 24 Fibre Adapter Plate, Shuttered, MM - Beige
AFR-00751-AQ	180600519	SC Duplex, 24 Fibre Adapter Plate, Shuttered, MM - Aqua
AFR-00752-EV	180600520	SC Duplex, 24 Fibre Adapter Plate, Shuttered, MM - Erica Violet
AFR-00753-BL	180600521	LC Quad, 48 Fibre Adapter Plate, Shuttered, SM - Blue
AFR-00754-GR	180600522	LC/APC Quad, 48 Fibre Adapter Plate, Shuttered, SM - Green
AFR-00755-OL	180600523	LC Quad, 48 Fibre Adapter Plate, Shuttered, MM - Beige
AFR-00756-AQ	180600524	LC Quad, 48 Fibre Adapter Plate, Shuttered, MM - Aqua
AFR-00757-EV	180600525	LC Quad, 48 Fibre Adapter Plate, Shuttered, MM - Erica Violet

Optical Fibre Solution Lightband™ Rack Mount Solutions



AFR-00470



91.A08**



AFR-00472



KFR-00034

1U Multi-Function Fibre Enclosure Accessories

Order No.	SAP No.	Description
AFR-00470	180600217	Universal Splice Tray, 24 Fibre with built in Cable Management, 1U Global Enclosure (Self Adhesive, 2 PC)
AFR-00472	180600219	Self Adhesive Cable Management Hub (3 PC)
KFR-00034	Consult Molex	Kevlar Retention Clamp (1 pc)
91.A0860	Consult Molex	Gland 4-8mm M20
91.A0870	Consult Molex	Gland 7.5-10mm M20
91.A0880	Consult Molex	Gland 9.5-13.2mm M20
91.A0890	Consult Molex	Gland 13-18mm M20
CSP-00030	Consult Molex	Mounting Adapter Screw (24 pack)

Optical Fibre Solution

Lightband™

Xtreme Density System Gen II



XFR-10192



24 Port LC Cassette



XFR-10144

Xtreme Density System Gen II

The Molex High Density Fibre Enclosures are designed for high density applications such as data centres, central offices or any other situation where high performing, high density and quick installation is required. The enclosures are available in two models, the 144 Fibre Enclosure and the class leading 192 Fibre Enclosure.

This innovative, robust, easy assemble and maintenance 1RU fibre enclosure has been designed for a MTP/MPO LC interface. This excellent space saving solution is ideal for network consolidation as its modular, scalable design provides flexibility for network partitioning and future growth. The rack mounted enclosure has been manufactured using durable powder/liquid coated steel construction ensures years of reliable service. The 19-inch chassis fits industry-standard EIA, ETSI and WECO rack mountable. The 1RU height conserves valuable rack space maximizing “real estate”. Quick Release pins on the enclosure front allows easy access as well as patch cord protection. Molex recommends our Bend Insensitive Uniboot Long Reach patch cords for ensuring correct fibre bend radius, lower cable weight and better cable management. These leads feature a long reach tab that allows for easy moves, adds and changes.

- 192 LC Ports, 8 cassettes and supply 1 MTP/MPO and 24 LC Ports breakout in each cassette
- 144 LC Ports, 12 cassettes and supply 1 MTP/MPO and 12 LC Ports breakout in each cassette
- Designed for 10G/40G/100G system migration
- Applied quad LC adapter or MTP/MPO adapter on adapter panel or cassette
- Combined with bend insensitive uniboot patch cords for maximum density and reliability
- Special guide PIN design made cassette easily plug and draw out
- Removable top cover providing easy access to the interior

Order No.	SAP No.	Description
XFR-10144	Consult Molex	HD 1 RU Enclosure 12x12F Cassette Capacity MPO/LC 144F
XFR-10192	Consult Molex	Xtreme Density 1 RU Enclosure 8x24F Cassette Capacity MPO/LC 192 F
XFR-14401	Consult Molex	HD 12F Cassette Capacity MPO/LC OS2 Low Loss
XFR-14402	Consult Molex	HD 12F Cassette Capacity MPO/LC OM3 Low Loss
XFR-14403	Consult Molex	HD 12F Cassette Capacity MPO/LC OM4 Low Loss
XFR-19201	Consult Molex	Xtreme Density 24F Cassette Capacity MPO/LC OS2 Low Loss
XFR-19202	Consult Molex	Xtreme Density 24F Cassette Capacity MPO/LC OM3 Low Loss
XFR-19203	Consult Molex	Xtreme Density 24F Cassette Capacity MPO/LC OM4 Low Loss
XCD-20001	Consult Molex	LC-LC OS1/2 LS0H 1M Long Reach Optical Fibre Patch Cord
XCD-20001.5	Consult Molex	LC-LC OS1/2 LS0H 1.5M Long Reach Optical Fibre Patch Cord
XCD-20002	Consult Molex	LC-LC OS1/2 LS0H 2M Long Reach Optical Fibre Patch Cord
XCD-20003	Consult Molex	LC-LC OS1/2 LS0H 3M Long Reach Optical Fibre Patch Cord
XCD-20005	Consult Molex	LC-LC OS1/2 LS0H 5M Long Reach Optical Fibre Patch Cord
XCD-20010	Consult Molex	LC-LC OS1/2 LS0H 10M Long Reach Optical Fibre Patch Cord
XCD-30001	Consult Molex	LC-LC OM3 LS0H 1M Long Reach Optical Fibre Patch Cord
XCD-30001.5	Consult Molex	LC-LC OM3 LS0H 1.5M Long Reach Optical Fibre Patch Cord
XCD-30002	Consult Molex	LC-LC OM3 LS0H 2M Long Reach Optical Fibre Patch Cord
XCD-30003	Consult Molex	LC-LC OM3 LS0H 3M Long Reach Optical Fibre Patch Cord
XCD-30005	Consult Molex	LC-LC OM3 LS0H 5M Long Reach Optical Fibre Patch Cord
XCD-30010	Consult Molex	LC-LC OM3 LS0H 10M Long Reach Optical Fibre Patch Cord
XCD-40001	Consult Molex	LC-LC OM4 LS0H 1M Long Reach Optical Fibre Patch Cord
XCD-40001.5	Consult Molex	LC-LC OM4 LS0H 1.5M Long Reach Optical Fibre Patch Cord
XCD-40002	Consult Molex	LC-LC OM4 LS0H 2M Long Reach Optical Fibre Patch Cord
XCD-40003	Consult Molex	LC-LC OM4 LS0H 3M Long Reach Optical Fibre Patch Cord
XCD-40005	Consult Molex	LC-LC OM4 LS0H 5M Long Reach Optical Fibre Patch Cord
XCD-40010	Consult Molex	LC-LC OM4 LS0H 10M Long Reach Optical Fibre Patch Cord



Specification Grade Fibre Enclosures

Specification Grade Fibre Optic Enclosures are configurable rack mount units used for storing and terminating incoming fibre cable. Designed to accommodate both the needs of the installer for the initial assembly and the end user for access, maintenance and fibre protection. Great care has gone into the design to protect fibre optic cables and patch cords from damage and to maintain stable optical integrity throughout the life and use of the enclosure.

- Standard 19" rack mount
- Lightweight, lockable, and removable aluminium hinged front and rear doors provide security
- Externally mounted cable strain relief bracket mounts to accommodate cable routing from above or below
- Labelling incorporated on hinged, drop-down metal front door
- 1U Fibre Enclosure - accommodates up to 4 6, 12 or 24 fibre plates, 4 ModLink™ Cassettes & 2 Splice Trays
- 2U Fibre Enclosure - accommodates up to 8 6, 12 or 24 fibre plates, 8 ModLink™ Cassettes & 8 Splice Trays
- 4U Fibre Enclosure - accommodates up to 24 6, 12 or 24 fibre plates, 24 ModLink™ Cassettes & 12 Splice Trays



Order No.	SAP No.	Description
RFR-00201	180370259	24-48 Port Specification Grade Fibre Enclosure - 1U
RFR-00202	180370260	48-96 Port Specification Grade Fibre Enclosure - 2U
RFR-00204	180660016	144-288 Port Specification Grade Fibre Enclosure - 4U
AFR-00222	180600069	Universal Splice Tray Carrier Kit
Accessories		
AFR-00222L	Consult Molex	Universal Splice Tray Mounting Bracket



Fibre Swing-Out Plastic Patch Panel

The Swing-Out Plastic Patch Panel is a light-weight, robust fibre optic patch panel designed for the installation of up to 48 fibres. The panel offers an economic alternative to metal fibre enclosures. The lower tray is designed to pivot enabling access to the pre-formed fibre and splice management areas for easy cable dressing and installation.

- High density, economic, 48 fibre enclosure
- Compatible with all common fibre adapters
- Manufactured from high-strength, light-weight material
- Lower tray of the panel pivots out for access to splice tray and pigtail routing area

Order No.	SAP No.	Description
RFR-00205	0180660017	Swing-Out Fibre Panel Chassis - 1U
RFR-00206	0180660018	Swing Out Fibre Panel Front Plate Blank
RFR-00207	0180660019	Swing Out Fibre Panel Shuttered Front Plate 6 Duplex SC SM
RFR-00208	0180660020	Swing Out Fibre Panel Shuttered Front Plate 6 SC MM
RFR-00209	0180660021	Swing Out Fibre Panel Shuttered Front Plate 12 Duplex LC SM
RFR-00210	0180660022	Swing Out Fibre Panel Front Plate 12 ST SM/MM
RFR-00212	180660024	Swing-Out Panel Shuttered Front Plate 12 DLC MM
RFR-00213	180660025	Swing-Out Panel Unshuttered Front Plate 6 DSC SM
RFR-00214	180660026	Swing-Out Panel Unshuttered Front Plate 6 DSC MM
Accessories		
KFR-00038	182680003	Front Plate Label Sheet (Pack 20)
KFR-00039	182680004	Cable Anchor Bracket Kit (1 x cable anchor bracket, 1 x 435mm bend limiting tube)
KFR-00040	182680005	45mm Fusion Splice Protector - 2.2mm (o.d.)

Fibre Optic Solution Lightband™ Enclosures



601 Fibre Enclosure

The 601 Fibre series wall mount system interface products are compact units for fibre optics. Available in ST, Duplex SC and LC versions they provide either 6, 8 or 12 fibre ports. The 601 fibre enclosure has a low profile design and provides the proper internal fibre management to ensure the integrity of the optical network. There is also provision for a user supplied seal for added security.

- Compact unit - 184mm x 127mm x 38mm
- Up to 24 Ports
- Available in Singlemode and Multimode fibre versions
- Available in ST, Duplex SC & LC versions
- Top, bottom and rear access

Order No.	SAP No.	Description
WFR-00010-02	180970009	6 Port ST 601 Enclosure, Multimode
WFR-00011-02	180970010	6 Port ST 601 Enclosure, Singlemode
WFR-00015-02	180970011	24 Port MTP 601 Enclosure, Singlemode/Multimode
WFR-00025-02	180970013	8 Port ST 601 Enclosure, Multimode
WFR-00026-02	180970014	8 Port ST 601 Enclosure, Singlemode
WFR-00028-02	180970016	8 Port Duplex SC 601 Enclosure, Multimode
WFR-00029-02	180970017	8 Port Duplex SC 601 Enclosure, Singlemode
WFR-00031-02	180970008	12 Port MT-RJ 601 Enclosure, Singlemode/Multimode
WFR-00034-02	180970073	12 Port LC 601 Enclosure, Multimode
WFR-00035-02	180970080	12 Port LC 601 Enclosure, Singlemode



WM-12

The WM-12 is a wall mounted steel enclosure that provides up to 24 fibre ports in a minimum of space. The WM-12 has an integral configurable panel that accepts up to 6 USO II modules. Its design also guarantees that all of the media will be protected and proper fibre bend radius is maintained.

- Fully configurable using fibre or copper modules
- Available with a fully lockable steel cover
- Accepts up to 6 x USO II modules



Order No.	SAP No.	Description
WFR-00018	0180090008	WM-12 Wall Mounted Steel Enclosure



MMI Enclosure

- Wall mounted units for storing and protecting optical fibre
- Holds 1.5m of up to 12 fibres with 900 micron buffers
- Accepts up to six USO II fascias, enabling Category 5e or Category 6 performance

- Modules sold separately
- MMI-R provides rugged metal cover protection
- Accommodates ST, SC, MT-RJ & LC Euromod 25 x 50mm and 50 x 50mm Angled Fibre Modules
- Accommodates PowerCat Euromod modules



Order No.	SAP No.	Description
WFR-00016-01	0180970023	MMI-Plastic Cover - Almond
WFR-00016-02	0180970024	MMI-Plastic Cover - White
WFR-00016-08	0180970025	MMI-Plastic Cover - Light Grey
WFR-00017	0180970021	MMI-R-Metal Cover - Graphite Grey

Fibre Optic Solution Lightband™ Enclosures



AFR-00338



AFR-00337

AFR-00334

AFR-00335

Fusion Splice Protectors



AFR-00470

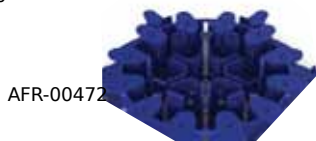

AFR-00472

Universal Splice Trays & Fusion Splice Protectors

The Universal Splice Tray is a configurable enclosure for both mechanical and fusion splices. Loose tube cable is routed into and out of the tray through adjustable tube grips located at each corner. Grips eliminate the need for cable ties and can be tightened and loosened preventing over-compression of the loose tube cable.

- Accepts mechanical and fusion splices
- Adjustable grips on each corner
- Prevents over-compression of the loose tube cable
- Accommodates up to 12 splices
- Fusion Splice Protectors are available in 45mm and 61mm lengths

Order No.	SAP No.	Description
♦AFR-00001	0180600027	Universal Splicing Tray
AFR-00334	180690050	5 Fibre Mechanical Splice Holder
♦AFR-00336	180690052	Universal Splice Tray - 24 Fibres
♦AFR-00338	180690054	Universal Splice Tray - Unloaded
AFR-00190	Consult Molex	Low Profile 24 Fibre Fusion Splice
AFR-00335	180690051	6 Fibre Fusion Splice Holder
AFR-00337	180690053	12 Fibre Fusion Splice Holder
AFR-00470	180600217	Universal Splice Tray, 24 Fibre with built in Cable Management for 1U Multi-Function Fibre Enclosure (Self Adhesive, 2 pcs)
AFR-00472	180600219	Self Adhesive Cable Management Hub (3 pcs)
KFR-00008	0180600025	45mm Fusion Splice Protector - 2.4mm (o.d.)
KFR-00009	0180600026	61mm Fusion Splice Protector - 2.4mm (o.d.)
KFR-00040	182680005	45mm Fusion Splice Protector - 2.2mm (o.d.)

♦ Compatible with Specification Grade Enclosures

Fibre Optic Solution Lightband™ Splicing



Modular Splice Cassettes

Molex's Modular Splice Cassette is an excellent way of managing vulnerable fibre optics, protecting them from dust and damage as a result of routine maintenance. The modular design is upgradeable and reusable. The Cassette is available in a number of pre-loaded kits or in an unloaded configuration.

- Fully integrated into Molex's Specification Grade Enclosures
- Maximises density - maximum 24 fibre capacity
- Provides perfect bend radius for splices
- Integrated cable management - prevents damage

Order No.	SAP No.	Description
AFR-00340	183190000	Modular Splice Cassette 6 Fibre Singlemode OS1 Duplex SC
AFR-00341	183190001	Modular Splice Cassette 6 Fibre Multimode OM1 Duplex SC
AFR-00342	183190002	Modular Splice Cassette 6 Fibre Multimode OM2 Duplex SC
AFR-00343	183190003	Modular Splice Cassette 6 Fibre Multimode OM3 Duplex SC
AFR-00344	183190004	Modular Splice Cassette 12 Fibre Singlemode OS1 Duplex SC
AFR-00345	183190005	Modular Splice Cassette 12 Fibre Multimode OM1 Duplex SC
AFR-00346	Consult Molex	Modular Splice Cassette 12 Fibre Multimode OM2 Duplex SC
AFR-00347	183190007	Modular Splice Cassette 12 Fibre Multimode OM3 Duplex SC
AFR-00348	183190008	Modular Splice Cassette 12 Fibre Singlemode OS1 Duplex LC
AFR-00349	183190009	Modular Splice Cassette 12 Fibre Multimode OM1 Duplex LC
AFR-00350	183190010	Modular Splice Cassette 12 Fibre Multimode OM2 Duplex LC
AFR-00351	183190011	Modular Splice Cassette 12 Fibre Multimode OM3 Duplex LC
AFR-00352	183190012	Modular Splice Cassette 24 Fibre Singlemode OS1 Quad LC
AFR-00353	183190013	Modular Splice Cassette 24 Fibre Multimode OM1 Quad LC
AFR-00354	183190014	Modular Splice Cassette 24 Fibre Multimode OM2 Quad LC
AFR-00355	183190015	Modular Splice Cassette 24 Fibre Multimode OM3 Quad LC
AFR-00382	183190017	Modular Splice Cassette 6 Fibre Singlemode OS1 ST
AFR-00383	183190018	Modular Splice Cassette 6 Fibre Multimode OM1 ST
AFR-00384	183190019	Modular Splice Cassette 6 Fibre Multimode OM2 ST
AFR-00380	183190016	Modular Splice Cassette Housing and Lid
AFR-00337	180690053	12 Fibre Fusion Splice Holder
AFR-00486	183190034	Modular Splice Cassette 6 Fibre OM4 Duplex SC - Erica Violet
AFR-00486L	183190035	Modular Splice Cassette 6 Fibre OM4 Duplex SC Low Loss - Erica Violet
AFR-00487	183190039	Modular Splice Cassette 12 Fibre OM4 Duplex SC - Erica Violet
AFR-00487L	183190040	Modular Splice Cassette 12 Fibre OM4 Duplex SC Low Loss - Erica Violet
AFR-00488	183190044	Modular Splice Cassette 12 Fibre OM4 Duplex LC - Erica Violet
AFR-00488L	183190045	Modular Splice Cassette 12 Fibre OM4 Duplex LC Low Loss - Erica Violet
AFR-00489	183190049	Modular Splice Cassette 24 Fibre OM4 Quad LC - Erica Violet
AFR-00489L	183190050	Modular Splice Cassette 24 Fibre OM4 Quad LC Low Loss - Erica Violet
AFR-00503	183190070	Modular Splice Cassette 6 Fibre OM4 Duplex SC - Aqua
AFR-00503L	183190071	Modular Splice Cassette 6 Fibre OM4 Duplex SC Low Loss - Aqua
AFR-00504	183190072	Modular Splice Cassette 12 Fibre OM4 Duplex SC - Aqua
AFR-00504L	183190073	Modular Splice Cassette 12 Fibre OM4 Duplex SC Low Loss - Aqua
AFR-00505	183190074	Modular Splice Cassette 12 Fibre OM4 Duplex LC - Aqua
AFR-00505L	183190075	Modular Splice Cassette 12 Fibre OM4 Duplex LC Low Loss - Aqua
AFR-00506	183190076	Modular Splice Cassette 24 Fibre OM4 Quad LC - Aqua
AFR-00506L	183190077	Modular Splice Cassette 24 Fibre OM4 Quad LC Low Loss - Aqua



1U Multi-Function Enclosure Gen II
Page 51



Connecting Data >
Connecting Specifiers
Delivering Efficiencies

Spend less time worrying about cost estimates and planning through Molex business tools.

- Cable Fill Rate Estimator
- Bill of Material Estimator
- Proposal Generator

molex

Fibre Optic Solution

Lightband™

Adapter Plates



6 Fibre Adapter Plates

6 Fibre Adapter Plates fit directly into most Molex fibre management enclosures and are compatible with the Modular Splice Cassette housing and Lid (AFR-00380). The simple design requires no tooling as the plates install with a simple snap rivet.

- RoHS Compliant
- Accommodates 6 or 12 fibres
- Available in Singlemode & Multimode versions
- For use within Molex's Fibre Management Systems
- Compatible with the Modular Splice Cassette housing and Lid (AFR-00380)

Order No.	SAP No.	Description
AFR-00357	180600135	ST 6 Fibre SM Adapter Plate
AFR-00358	180600136	SC Duplex 6 Fibre SM Adapter Plate - Blue
AFR-00360	180600138	SC Duplex 6 Fibre MM Adapter Plate - Beige
AFR-00363	180600141	6 Fibre Blank Plastic pack of 4
AFR-00364	180600142	ST 6 Fibre Adapter Plate unloaded
AFR-00371	180600149	ST 6 Fibre MM Adapter Plate
AFR-00372	180600150	SC Duplex 6 Fibre MM OM3 Adapter Plate - Aqua
AFR-00500	1890600246	SC Duplex 6 Fibre MM OM4 Adapter Plate - Erica Violet



1U Multi-Function Enclosure Gen II Page 51

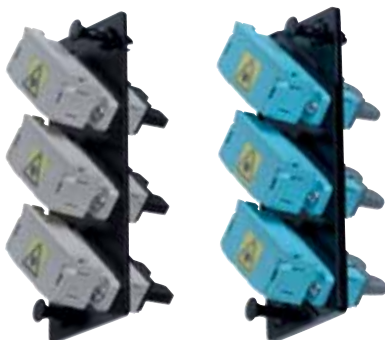

6 Fibre Shuttered Adapter Plates

6 Fibre Shuttered Adapter Plates fit directly into most Molex fibre management enclosures. The simple design requires no tooling as the plates install with a simple snap rivet. Shuttered 6 Fibre Plates feature Molex's unique shuttered technology which protects installers and end users from LED/Laser light emissions.

- RoHS Compliant
- Accommodates 6 or 12 fibres
- Available in Singlemode & Multimode versions
- For use within Molex's Fibre Management Systems
- Unique shuttered feature protects from harmful light emissions

Order No.	SAP No.	Description
AFR-00114	182080069	6 Fibre Shuttered Duplex ST-SC Adapter Plate, Singlemode
AFR-00116	180600040	6 Fibre Shuttered Duplex ST-SC Adapter Plate, Multimode
AFR-00118	180600042	6 Fibre Shuttered Duplex SC Adapter Plate, Singlemode
AFR-00120	180600044	6 Fibre Shuttered Duplex SC Adapter Plate, Multimode
AFR-00229	180600100	6 Fibre Shuttered SC/APC Adapter Plate, Singlemode
AFR-00311	180600078	6 Fibre Shuttered Duplex SC Adapter Plate, Multimode OM3



1U Multi-Function Enclosure Gen II Page 51



6 Fibre Angled Adapter Plates

Angled 6 Fibre SC Adapter Plates fit directly into most Molex fibre management enclosures. The simple design requires no tooling as the plates install with a simple snap rivet, making installation and changes simple. Adapters on Angled 6 Fibre Plates are fixed at a 30 degree angle to protect installers and end users from LED/Laser light emissions.

- RoHS Compliant
- Accommodates 6 fibres
- Available with Duplex SC and ST adapters
- Available in Singlemode & Multimode versions
- For use within Molex's Fibre Management Systems
- Angled design assists with maintaining the correct fibre bend radius

Order No.	SAP No.	Description
AFR-00182	180600129	6 Fibre Angled Duplex SC Adapter Plate, Multimode
AFR-00548-EV	180600310	6 Fibre Angled Duplex SC Adapter Plate, OM3 - Aqua
AFR-00182-EV	180600310	6 Fibre Angled Duplex SC Adapter Plate, OM4 MM - Erica Violet
AFR-00183	180600116	6 Fibre Angled Duplex SC Adapter Plate, Singlemode
AFR-00185	180600131	6 Fibre Angled ST Adapter Plate, Singlemode
AFR-00186	180600132	6 Fibre Angled Duplex SC-ST Adapter Plate, Multimode
AFR-00187	180600133	6 Fibre Angled Duplex SC-ST Adapter Plate, Singlemode



1U Multi-Function Enclosure Gen II Page 51

Fibre Optic Solution

Lightband™

Adapter Plates



12 Fibre Adapter Plates

12 Fibre Adapter Plates fit directly into most Molex fibre management enclosures. The simple design requires no tooling as the plates install with a simple snap rivet.

- RoHS Compliant
- Accommodates 12 fibres
- Available in Singlemode & Multimode versions
- For use within Molex's Fibre Management Systems



1U Multi-Function Enclosure Gen II Page 51

Order No.	SAP No.	Description
AFR-00365	180600143	LC Duplex 12 Fibre SM Adapter Plate - Blue
AFR-00366	180600144	LC Duplex 12 Fibre MM Adapter Plate - Beige
AFR-00376	Consult Molex	LC Duplex 12 Fibre MM OM3 Adapter Plate - Aqua
AFR-00376-EV	180600305	LC Duplex 12 Fibre Adapter Plate, Multimode - Erica Violet
AFR-00362	180600140	SC Duplex 12 Fibre Adapter Plate, Multimode - Beige
AFR-00368	180600146	SC Duplex 12 Fibre Adapter Plate, Singlemode - Blue
AFR-00374	180600152	SC Duplex 12 Fibre Adapter Plate, Multimode OM3 - Aqua
AFR-00501	180600247	SC Duplex 12 Fibre Adapter Plate, Multimode OM4 - Erica Violet



12 Fibre Shuttered Adapter Plates

12 Fibre Shuttered Adapter Plates fit directly into most Molex fibre management enclosures. The simple design requires no tooling as the plates install with a simple snap rivet. Shuttered 12 fibre plates feature Molex's unique shuttered technology which protect installers and end users from LED/Laser light emissions.

- RoHS Compliant
- Accommodates 12 fibres
- Available in Singlemode & Multimode versions
- For use within Molex's Fibre Management Systems
- Unique shuttered feature protects from harmful light emissions



1U Multi-Function Enclosure Gen II Page 51

Order No.	SAP No.	Description
AFR-00370	180600148	LC Quad 12 Fibre MM Adapter Plate - Beige
AFR-00369	180600147	LC Quad 12 Fibre SM Adapter Plate - Blue
AFR-00375	180600153	LC Quad 12 Fibre MM OM3 Adapter Plate - Aqua
AFR-00375-EV	180600306	LC Quad 12 Fibre MM OM4 Adapter Plate - Erica Violet



24 Fibre Adapter Plates

24 Fibre Adapter Plates fit directly into most Molex fibre management enclosures. The simple design requires no tooling as the plates install with a simple snap rivet.

- RoHS Compliant
- Accommodates 24 fibres
- Available in Singlemode & Multimode versions
- For use within Molex's Fibre Management Systems



1U Multi-Function Enclosure Gen II Page 51

Order No.	SAP No.	Description
AFR-00377	180600155	LC Quad 24 Fibre MM OM1 Adapter Plate - Beige
AFR-00378	180600156	LC Quad 24 Fibre MM OM3 Adapter Plate - Aqua
AFR-00379	180600157	LC Quad 24 Fibre SM OS1 Adapter Plate - Blue
AFR-00502	180600248	LC Quad 24 Fibre MM OM4 Adapter Plate - Erica Violet

Fibre Optic Solution

Lightband™

Adapters



Duplex SC Adapters

Duplex SC adapters feature either a snap or flange mount and are designed to support the TIA/EIA commercial building telecommunication wiring standards.

- RoHS Compliant
- NTT-SC and Bellcore 326 compliant connectors
- Meets TIA/EIA 568-B.3 and IEC 874-109 standards
- Unique shuttered feature protects from harmful light emissions - Available upon application

Order No.	SAP No.	Description
18282-0033	182820033	SC/SC Duplex MM Phosphor Bronze Flange Mount Unshuttered - Beige
18282-0034	182820034	SC/SC Duplex MM Phosphor Bronze Snap Unshuttered - Beige
18282-0035	182820035	SC/SC Duplex MM Phosphor Bronze Flange Mount Unshuttered - Aqua
18282-0036	182820036	SC/SC Duplex MM Phosphor Bronze Snap Unshuttered - Aqua
18282-0037	182820037	SC/SC Duplex SM Zirconia Flange Mount Unshuttered - Blue
18282-0038	182820038	SC/SC Duplex SM Zirconia Snap Mount Unshuttered - Blue
18282-0090	182820090	SC Duplex MM OM4 Phosphor Bronze Snap Unshuttered - Erica Violet
18282-0091	182820091	SC Duplex MM OM4 Phosphor Bronze Flange Mount Unshuttered - Erica Violet
18282-0107	182820107	SC Duplex MM OM4 Zirconia Flange Mount Unshuttered - Erica Violet
18282-0111	182820111	SC Duplex MM OM4 Zirconia Snap Mount Unshuttered - Erica Violet
106167-0510A	Consult Molex	SC/SC Duplex MM Phosphor Bronze Flange Mount Shuttered - Beige
106167-0610	Consult Molex	SC/SC Duplex MM Phosphor Bronze Snap Mount Shuttered - Beige
106166-0500A	Consult Molex	SC/SC Duplex SM Zirconia Flange Mount Shuttered - Blue
106166-0600	Consult Molex	SC/SC Duplex SM Zirconia Snap Mount Shuttered - Blue
106167-0410	Consult Molex	SC/SC Duplex MM Phosphor Bronze Flange Mount Shuttered - Aqua
106167-0620	Consult Molex	SC/SC Duplex MM Phosphor Bronze Snap Shuttered - Aqua
106166-0200	Consult Molex	SC Duplex Adapter Shutter - Blue
106166-0210	Consult Molex	SC Duplex Adapter Shutter - Beige



Duplex SC/ST Adapters

Duplex SC/ST adapters feature either a snap or flange mount and are designed to support the TIA/EIA commercial building telecommunication wiring standards.

- RoHS Compliant
- NTT-SC and Bellcore 326 compliant connectors
- Meets TIA/EIA 568-B.3 and IEC 874-109 standards
- Unique shuttered feature protects from harmful light emissions - Available upon application

Order No.	SAP No.	Description
106167-1000	1061671000	SC/ST Duplex, Singlemode, Phosphor Bronze, Flange Mount
106167-1010	1061671010	SC/ST Duplex, Multimode, Phosphor Bronze, Flange Mount
106167-1100	1061671100	SC/ST Duplex, Singlemode, Phosphor Bronze, Snap Mount
106167-1110	1061671110	SC/ST Duplex, Multimode, Phosphor Bronze, Snap Mount
106167-1500	1061671500	SC/ST Shuttered Duplex, Singlemode, Phosphor Bronze, Flange Mount
106167-1510	1061671510	SC/ST Shuttered Duplex, Multimode, Phosphor Bronze, Flange Mount
106167-1600	1061671600	SC/ST Shuttered Duplex, Singlemode, Phosphor Bronze, Snap Mount
106167-1610	1061671610	SC/ST Shuttered Duplex, Multimode, Phosphor Bronze, Snap Mount

Fibre Optic Solution

Lightband™

Adapters



Duplex SC/APC Adapters

Duplex SC/APC adapters feature either a snap or flange mount and are designed for use with Angled Polish Connectors.

- RoHS Compliant
- NTT-SC and Bellcore 326 compliant connectors
- Meets TIA/EIA 568-B.3 and IEC 874-109 standards
- Unique shuttered feature protects from harmful light emissions - Available upon application

Order No.	SAP No.	Description
18282-0039	182820039	SC/SC APC Duplex SM Zirconia Flange Mount Unshuttered - Green
18282-0040	182820040	SC/SC APC Duplex SM Zirconia Snap Mount Unshuttered - Green
106166-0550	Consult Molex	SC/SC APC Duplex SM Zirconia Flange Mount Shuttered - Green
106166-0650	Consult Molex	SC/SC APC Duplex SM Zirconia Snap Mount Shuttered - Green



LC Adapters

The LC adapter is the result of increased demands for smaller easier-to-use fibre connectivity. The LC adapter has reduced the space requirements on equipment bays and distribution panels by 50%.

- RoHS Compliant
- Unique shuttered feature protects from harmful light emissions - Available upon application

Order No.	SAP No.	Description
106127-1300A	1061271300A	LC Shuttered Duplex, Singlemode, Zirconia Alignment
106127-1310A	1061271310A	LC Shuttered Duplex, Multimode, Phosphor Bronze Alignment
18282-0041	182820041	LC Unshuttered Duplex, MM, Flange Mount, Phosphor Bronze Alignment - Beige
18282-0042	182820042	LC Unshuttered Duplex, MM, Snap Mount, Phosphor Bronze Alignment - Beige
18282-0043	182820043	LC Unshuttered Duplex, MM, Flange Mount, Phosphor Bronze Alignment - Aqua
18282-0044	182820044	LC Unshuttered Duplex, MM, Snap Mount, Phosphor Bronze Alignment - Aqua
18282-0045	182820045	LC Unshuttered Duplex, SM, Flange Mount, Zirconia Alignment - Blue
18282-0046	182820046	LC Unshuttered Duplex, SM, Snap Mount, Zirconia Alignment - Blue
18282-0047	182820047	LC Unshuttered APC Duplex, SM, Flange Mount, Zirconia Alignment - Green
18282-0048	182820048	LC Unshuttered APC Duplex, SM, Snap Mount, Zirconia Alignment - Green
18282-0089	182820089	LC Unshuttered Duplex MM OM4, Snap Mount, Zirconia Alignment - Erica Violet
18282-0092	182820092	LC Unshuttered Duplex MM OM4, Flange Mount, Zirconia Alignment - Erica Violet
106127-0410	Consult Molex	LC-LC Shuttered Duplex MM OM1/OM2 Phosphor Bronze Snap Mount - Beige
106127-0350	Consult Molex	LC-LC Shuttered Duplex MM OM3 Phosphor Bronze Flange Mount - Aqua
106127-1610	Consult Molex	LC-LC Shuttered Duplex MM OM3 Phosphor Bronze Snap Mount - Aqua
106127-1400	Consult Molex	LC-LC Shuttered Duplex SM OS1 Zirconia Ceramic Snap Mount - Blue
106127-1350	Consult Molex	LC-LC Shuttered Duplex SM OS1 Zirconia Ceramic Flange Mount - Green
106127-1450	Consult Molex	LC-LC Shuttered Duplex SM OS1 Zirconia Ceramic Snap Mount - Green

Fibre Optic Solution Lightband™ Connectors

Molex offers a comprehensive range of adapters and connectors in both Multimode and Singlemode variants. Designed to the highest performance specifications, meeting international standards and providing low insertion loss, the connectors are available as

heat-cured, cold cured and field terminable variants. The adapters feature either snap or flange mount fixings and are designed with the latest polymer and ceramic materials.

Connectors - Oven Cure

LC Connectors

Order No.	SAP No.	Description	MM/SM	Ferrule	Boot	Colour	Action
18262-0041	182620041	LC Oven Cure Connector	SM	Zirconia	900µm	Blue	Epoxy
18262-0034	182620034	LC Oven Cure Connector	MM	Zirconia	900µm	Beige	Epoxy

SC Connectors

Order No.	SAP No.	Description	MM/SM	Ferrule	Boot	Colour	Action
18262-0043	182620043	SC Oven Cure Connector	SM	Zirconia	900µm	Blue	Epoxy
18262-0033	182620033	SC Oven Cure Connector	MM	Zirconia	900µm	Beige	Epoxy



Connectors - Pre-Polished, Pre-Assembled, Xpress G2

Molex's Xpress G2 (second generation) Pre-Polished, Pre-Assembled Connectors provide quick reliable terminations and are easy to use.

- Quick assembly
- Low tooling investment - only strip and cleaving tool required
- Reliable performance - same environmental endurance as conventional connectors
- Multiple formats available - SC and LC form factors
- Available in Singlemode, Multimode, Angled Polish in 900µm & 250µm format

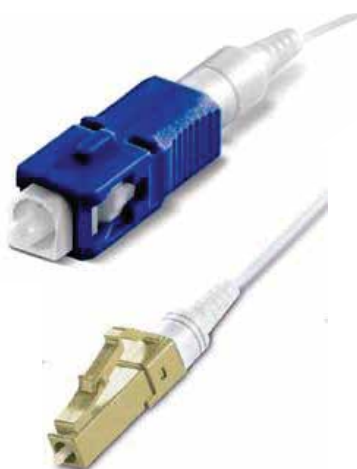

Order No.	SAP No.	Description
AFR-00387	182620013	LC Multimode OM1 250/900µm Beige 10 x Connector Kit
AFR-00388	182620014	LC Multimode OM2 250/900µm Black 10 x Connector Kit
AFR-00389	182620015	LC Multimode OM3 10g 250/900µm Aqua 10 x Connector Kit
AFR-00390	182620016	LC Singlemode OS1 250/900µm Blue 10 x Connector Kit
AFR-00391	182620017	SC Multimode OM1 250/900µm Beige 10 x Connector Kit
AFR-00392	182620018	SC Multimode OM2 250/900µm Black 10 x Connector Kit
AFR-00393	182620019	SC Multimode OM3 10g 250/900µm Aqua 10 x Connector Kit
AFR-00394	182620020	SC Singlemode OS1 250/900µm Blue 10 x Connector Kit
AFR-00395	182620021	SC/APC Singlemode OS1 250/900µm APC Green 10 x Connector Kit

Fibre Optic Solution Lightband™ Adapters



ST Adapters

Order No.	SAP No.	Description	MM/SM	Sleeve	Colour	Mount
AFR-00200	180600093	ST/ST Duplex	SM	Zirconia	Blue	Flange
AFR-00201	180600094	ST/ST Duplex	MM	P Bronze	Beige	Flange
18282-0065	182820065	ST Simplex	SM/MM	Zirconia	Metal	Double-D
18282-0057	182820057	ST Simplex	SM/MM	P Bronze	Metal	Double-D

SC Adapters (compatible with Multi-Function Enclosure unloaded SC adapter plates)



Duplex SC Adapters

Order No.	SAP No.	Description
AFR-00202	182620013	Duplex SC Singlemode OS1/2 Unshuttered Adapter - Blue
AFR-00203	182620013	Duplex SC Multimode OM1/2 Unshuttered Adapter - Beige
18282-0035	182620017	SC Multimode OM3 Unshuttered Adapter - Aqua
18282-0091	182820091	SC Multimode OM3 Unshuttered Adapter - Erika Violet

LC Adapters (compatible with Multi-Function Enclosure unloaded SC adapter plates)



Duplex Adapters

Order No.	SAP No.	Description
18282-0045	182820045	Duplex LC Singlemode OS1/2 Unshuttered Adapter - Blue
106127-1300	1061271300	Duplex LC Singlemode OS1/2 Shuttered Adapter - Blue
18282-0041	182820041	Duplex LC Multimode OM1/2 Unshuttered Adapter - Beige
106127-0310	1061277030	Duplex LC Multimode OM1/2 Shuttered Adapter - Beige
18282-0043	182820043	Duplex LC Multimode OM3 Unshuttered Adapter - Aqua
106127-0350	1061270350	Duplex LC Multimode OM3 Shuttered Adapter - Aqua
18282-0116	182820116	Duplex LC Multimode OM3 Unshuttered Adapter - Erika Violet

Quad Adapters



Order No.	SAP No.	Description
18282-0053	182820053	Quad LC Singlemode OS1/2 Unshuttered Adapter - Blue
106123-0200	1061230200	Quad LC Singlemode OS1/2 Shuttered Adapter - Blue
18282-0049	182820049	Quad LC Multimode OM1/2 Unshuttered Adapter - Beige
106123-1200	1061231200	Quad LC Multimode OM1/2 Shuttered Adapter - Beige
18282-0051	182820051	Quad LC Multimode OM3 Unshuttered Adapter - Aqua
106123-3200	1061233200	Quad LC Multimode OM3 Shuttered Adapter - Aqua
18282-0126	182820126	Quad LC Multimode OM3 Unshuttered Adapter - Erika Violet

Fibre Optic Solution Lightband™ Fibre-To-The-Desk

Molex offers a comprehensive range of fibre-to-the-desk modular systems to suit all applications and market requirements. Elegantly designed, these products offer a low profile and versatile modular construction, allowing the user to easily expand the network as it grows.

Supporting SC, LC and ST fibre adapters, Molex's work area solutions are suitable for both Singlemode and Multimode installations and include Molex's unique "shuttered" technology protecting the user from harmful light emissions.



50 x 50mm Angled Modules

50 x 50mm Angled modules ensure that correct bend radius is maintained in a fibre-to-the-desk environment and feature shuttered adapters, protecting the user from harmful light emissions.

- Available in Singlemode & Multimode versions
- Permits a 30mm bend radius
- For use within Euromod and USO II™ System of Wallplates

Order No.	SAP No.	Description
MEU-00005-02	184000314	Angled ST Module, Multimode - 4 Adapters
MEU-00006-02	Consult Molex	Angled ST Module, Singlemode - 4 Adapters
MEU-00007-02	Consult Molex	Angled ST Module, Multimode - 2 Adapters
MEU-00009-02	181210016	Angled Shuttered Duplex SC Module, Multimode -2 Adapters
MEU-00010-02	182620000	Angled Shuttered Duplex SC Module, Singlemode -2 Adapters
MEU-00011-02	Consult Molex	Angled Shuttered Duplex SC Module, Multimode -1 Adapter
MEU-00012-02	Consult Molex	Angled Shuttered Duplex SC Module, Singlemode -1 Adapter
MEU-00013-02	182620001	Angled Shuttered Duplex SC-ST Module, Multimode - 2 Adapters
MEU-00014-02	182620002	Angled Shuttered Duplex SC-ST Module, Singlemode - 2 Adapters
MEU-00048-02	181210017	Angled Shuttered LC, Singlemode - 2 Adapters
MEU-00049-02	182620005	Angled Shuttered LC, Multimode - 2 Adapters



Work Area Solutions
Page87



25x50mm Modules

25x50mm modules provide a Singlemode or Multimode solution, supporting SC, ST and LC fibre technology.

- Available in Singlemode & Multimode versions
- For use within USO II System of Wallplates
- For use within WM-12 wall mount fibre management system

Order No.	SAP No.	Description
17.A0162	0181210015	25 x 50mm Duplex SC Module, Multimode - 1 Adapter
17.A0172	0181210014	25 x 50mm Duplex SC Module, Singlemode - 1 Adapter
17.A0182	0182620006	25 x 50mm Duplex SC-ST Module, Multimode - 1 Adapter
17.A0192	0182620007	25 x 50mm Duplex SC-ST Module, Singlemode - 1 Adapter
17.A0202	0184000467	25 x 50mm Shuttered Duplex SC Module, Multimode - 1 Adapter
17.A0212	0184000466	25 x 50mm Shuttered Duplex SC Module, Singlemode - 1 Adapter
17.A0222	0182620008	25 x 50mm Shuttered Duplex SC-ST Module, Multimode - 1
MEU-00029-02	0181490006	25 x 50mm LC Module, Singlemode - 2 Adapters
MEU-00067-02	0182620012	25 x 50mm LC Module, Multimode - 2 Adapters



Work Area Solutions
Page 87



Media Configurable
Pages D-12

Single Bezel ST Modules

Designed for use within the Molex Synergy range of wallplates and surface blocks, ST jacks are available in five colours and provide Singlemode and Multimode performance.

- RoHS Compliant
- Available in Singlemode & Multimode versions
- DataGate™ footprint
- Available in 5 colours



Order No.	SAP No.	Description
MSY-00003-**	Consult Molex	Single ST Module, Singlemode/Multimode

** Colour Options - 01 = Almond, 02 = White, 04 = Black, 05 = Ivory, 08 = Light Grey

Fibre Optic Solution

Lightband™

Fibre-To-The-Desk



Single Bezel SC Modules

Designed for use within the Molex Synergy™ range of wallplates and surface blocks, SC jacks are available in five colours and provide Singlemode performance.

- RoHS Compliant
- Designed to fit into Synergy, Streamline, Signature & USO II™ system of wallplates and surface blocks
- Available in 5 colours
- DataGate™ footprint



Work Area Solutions
Page 28

Media Configurable
Page 91

Order No.	SAP No.	Description
MSY-00018-**	Consult Molex	Simplex Shuttered SC Module, Singlemode

** Colour Options - 01 = Almond, 02 = White, 04 = Black, 05 = Ivory, 08 = Light Grey



Single Bezel LC Modules

Designed for use within the Molex Synergy range of wallplates and surface blocks, LC modules are available in five colours and provide Multimode performance.

- RoHS Compliant
- Designed to fit into Synergy, Streamline, Signature & USO II system of wallplates and surface blocks
- Available in 5 colours
- DataGate footprint



Work Area Solutions
Page 28

Media Configurable
Page 91

Order No.	SAP No.	Description
MSY-00040-**	Consult Molex	Single LC Module, Multimode

** Colour Options - 01 = Almond, 02 = White, 04 = Black, 05 = Ivory, 08 = Light Grey



MMI Enclosure

- Wall mounted units for storing and protecting optical fibre
- Holds 1.5m of up to 12 fibres with 900 micron buffers
- Accepts up to six USO II fascias, enabling Category 5e or Category 6 performance

- Modules sold separately
- MMI-R provides rugged metal cover protection
- Accommodates ST, SC, MT-RJ & LC Euromod 25 x 50mm and 50 x 50mm Angled Fibre Modules



Fibre Modules
Page 66

Order No.	SAP No.	Description
WFR-00016-01	0180970023	MMI-Plastic Cover - Almond
WFR-00016-02	0180970024	MMI-Plastic Cover - White
WFR-00016-08	0180970025	MMI-Plastic Cover - Light Grey
WFR-00017	0180970021	MMI-R-Metal Cover - Graphite Grey

Fibre Optic Solution

Lightband™

Fibre-To-The-Desk



50 x 50mm Angled Modules

50 x 50mm Angled modules ensure that correct bend radius is maintained in a fibre-to-the-desk environment and feature shuttered adapters, protecting the user from harmful light emissions.

- Available in Singlemode & Multimode versions
- Permits a 30mm bend radius
- For use within Euromod and USO II System of Wallplates

Order No.	SAP No.	Description
MEU-00005-02	184000314	Angled ST Module, Multimode - 4 Adapters
MEU-00006-02	Consult Molex	Angled ST Module, Singlemode - 4 Adapters
MEU-00007-02	Consult Molex	Angled ST Module, Multimode - 2 Adapters
MEU-00009-02	181210016	Angled Shuttered Duplex SC Module, Multimode -2 Adapters
MEU-00010-02	182620000	Angled Shuttered Duplex SC Module, Singlemode -2 Adapters
MEU-00011-02	Consult Molex	Angled Shuttered Duplex SC Module, Multimode -1 Adapter
MEU-00012-02	Consult Molex	Angled Shuttered Duplex SC Module, Singlemode -1 Adapter
MEU-00013-02	182620001	Angled Shuttered Duplex SC-ST Module, Multimode - 2 Adapters
MEU-00014-02	182620002	Angled Shuttered Duplex SC-ST Module, Singlemode - 2 Adapters
MEU-00048-02	181210017	Angled Shuttered LC, Singlemode - 2 Adapters
MEU-00049-02	182620005	Angled Shuttered LC, Multimode - 2 Adapters



Outlet Configuration Solutions Page 87



Connecting Data >
Connecting Users
Delivering Reliability

molex[®]

Mission critical applications Simply Solved >



ModLink is an ideal solution for mission critical applications, where fast installation is paramount and reconfigurations are frequent or managed in-house.

A viable tool for rapid deployment of an alternate data recovery system. In the event of damage or failure to a vital fibre backbone, the link can be quickly re-established without the need of technicians.



Pre-Terminated Solutions

Product Features

Compactly sized, individual ModLink cassettes simply click into Molex's range of rack mount fibre management panels and enclosures, providing up to 96 ports in a 1U rack space. They offer front port identification plus labelling field on the cassette top for fibre documentation. Cables utilise OFNP or LS0H rated round loose tube cable featuring a flexible outer jacket that is easy to bend, route and install.

Supports all major fibre connector technologies

The ModLink system is available to support LC, SC, or MT-RJ fibre connectivity. Providing up to 24 fibre ports in each cassette, the SC and LC range are designed to adhere to TIA/EIA 568-C.3, ISO/IEC 11801 and AS/NZS 3080 international fibre performance standards, the ModLink system supports OM1, OM2, OM3, OM4, OS1 and OS2 fibre applications

ModLink Cassettes

ModLink Cassettes provide a cost-effective, quick and easy fibre system, for backbone and to-the-desk applications. 12 and 24 Port LC ModLink Cassettes provide premium factory-controlled optical performance, enabling flexible system configuration and fast, economical installation. The cassettes are low loss ready, ideal for 40G/100G providing consistent and error free performance. Simply plug the cable into the rear of the unit and the link is operational - an excellent solution for fast-track installations.

ModLink Cables

ModLink LS0H and OFNP rated cables are factory terminated on both ends with multi-fibre MTP® connectors for maximum fibre density. The round, flexible outer jacket is easy to bend, route and install. The cable offers standard and industry-leading low insertion loss (0.35dB maximum insertion loss for laser optimised OM3/4 cables and OS1/2 cables, 0.10dB typical) varieties. ModLink advanced fibre optic cables are 100% tested.



Pre-Terminated Solutions ModLink™ Fibre Plug & Play



12 Port LC ModLink Cassettes

ModLink Cassettes provide a cost-effective, quick and easy fibre system, for backbone and to-the-desk applications. 12 Port LC ModLink Cassettes provide premium factory-controlled optical performance, enabling flexible system configuration and fast, economical installation. Simply plug the cable into the rear of the unit and the link is operational - an excellent solution for fast-track installations.

- Self-contained fibre optic patching enclosures convert the MTP/MPO interface to a standard LC, SC, MT-RJ or ST coupler
- Industry-leading low insertion loss for OS1/2, OM3 & and OM4 Cassettes
- Available in Singlemode & Multimode versions
- Front port identification plus labelling field on cassette top for fibre documentation
- For use within Molex's Fibre Management Systems

Order No.	SAP No.	Description
MLCDSC12OS2L	Consult Molex	12 Port ModLink Cassette, Duplex SC, OS1/2 Singlemode
MLCMTR12OS2L	Consult Molex	12 Port ModLink Cassette, MTRJ, OS1/2 Singlemode
MLCDLC12OS2L	Consult Molex	12 Port ModLink Cassette, Duplex LC, OS1/2 Singlemode
MLCQLC12OS2L	Consult Molex	12 Port ModLink Cassette, Quad LC, OS1/2 Singlemode
MLCDSC12OM1	Consult Molex	12 Port ModLink Cassette, Duplex SC, OM1 62.5µm Multimode
MLCMTR12OM1	Consult Molex	12 Port ModLink Cassette, MT-RJ, OM1 62.5µm Multimode
MLCDLC12OM1	0181810142	12 Port ModLink Cassette, Duplex LC, OM1 62.5µm Multimode
MLCQLC12OM1	0180370268	12 Port ModLink Cassette, Quad LC, OM1 62.5µm Multimode
MLCDSC12OM2	Consult Molex	12 Port ModLink Cassette, Duplex SC, OM2 50µm Multimode
MLCMTR12OM2	Consult Molex	12 Port ModLink Cassette, MT-RJ, OM2 50µm Multimode
MLCDLC12OM2	0181810147	12 Port ModLink Cassette, Duplex LC, OM2 50µm Multimode
MLCQLC12OM2	0180370267	12 Port ModLink Cassette, Quad LC, OM2 50µm Multimode
MLCDSC12OM3L	Consult Molex	12 Port ModLink Cassette, Duplex SC, OM3 50µm Multimode, Low Loss
MLCMTR12OM3L	Consult Molex	12 Port ModLink Cassette, MTRJ, OM3 50µm Multimode, Low Loss
MLCDLC12OM3L	Consult Molex	12 Port ModLink Cassette, Duplex LC, OM3 50µm Multimode, Low Loss
MLCQLC12OM3L	Consult Molex	12 Port ModLink Cassette, Quad LC, OM3 50µm Multimode, Low Loss
MLCDSC12OM4L	Consult Molex	12 Port ModLink Cassette, Duplex SC, OM4 50µm Multimode, Low Loss
MLCMTR12OM4L	Consult Molex	12 Port ModLink Cassette, MT-RJ, OM4 50µm Multimode, Low Loss
MLCDLC12OM4L	Consult Molex	12 Port ModLink Cassette, Duplex LC, OM4 50µm Multimode, Low Loss
MLCQLC12OM4L	Consult Molex	12 Port ModLink Cassette, Quad LC, OM4 50µm Multimode, Low Loss



24 Port Quad LC ModLink Cassettes

ModLink Cassettes provide a cost-effective, quick and easy fibre system for backbone and to-the-desk applications. 24 Port Quad LC ModLink Cassettes provide premium factory-controlled optical performance, enabling flexible system configuration and fast, economical installation. Simply plug the cable into the rear of the unit and the link is operational - an excellent solution for fast-track installations.

- Self-contained fibre optic patching enclosures convert the MTP/MPO interface to a standard LC, SC, MT-RJ or ST coupler
- Industry-leading low insertion loss for OS1/2, OM3 & and OM4 Cassettes
- Available in Singlemode & Multimode versions
- Front port identification plus labelling field on cassette top for fibre documentation
- For use within Molex's Fibre Management Systems

Order No.	SAP No.	Description
MLCQLC24OM1	Consult Molex	24 Port ModLink Cassette, Quad LC, OM1 62.5µm Multimode
MLCQLC24OM2	Consult Molex	24 Port ModLink Cassette, Quad LC, OM2 50µm Multimode
MLCQLC24OM3L	Consult Molex	24 Port ModLink Cassette, Quad LC, Low Loss, OM3 50µm Multimode
MLCQLC24OM4L	Consult Molex	24 Port ModLink Cassette, Quad LC, Low Loss, OM4 50µm Multimode
MLCQLC24OS2L	Consult Molex	24 Port ModLink Cassette, Quad LC, Low Loss, OS2 Singlemode

Pre-Terminated Solutions

ModLink™ Fibre

Plug & Play



ModLink Cables

- LS0H rated ribbon cables are factory terminated on both ends with multi-fibre MTP® connectors for maximum fibre density
- Round, flexible outer jacket is easy to bend, route and install
- Patented flexible transition sleeve maintains the routing feature of the round cable, absorbs vibration shock and provides an ideal surface to secure the MTP connector
- Industry-leading low insertion loss (0.35dB Maximum Insertion Loss for Laser Optimised OM3/4 Cables and OS1/2 Cables, 0.10dB Typical)
- ModLink advanced fibre optic cables are 100% tested
- Pulling eyes installed to protect the assembly during installation
- 4.5mm o.d.
- Standard and Low Loss versions available

Part No. Matrix - Substitute the correct code number or letter to determine the assembly construction

91-XAABB-YLLLC-E*

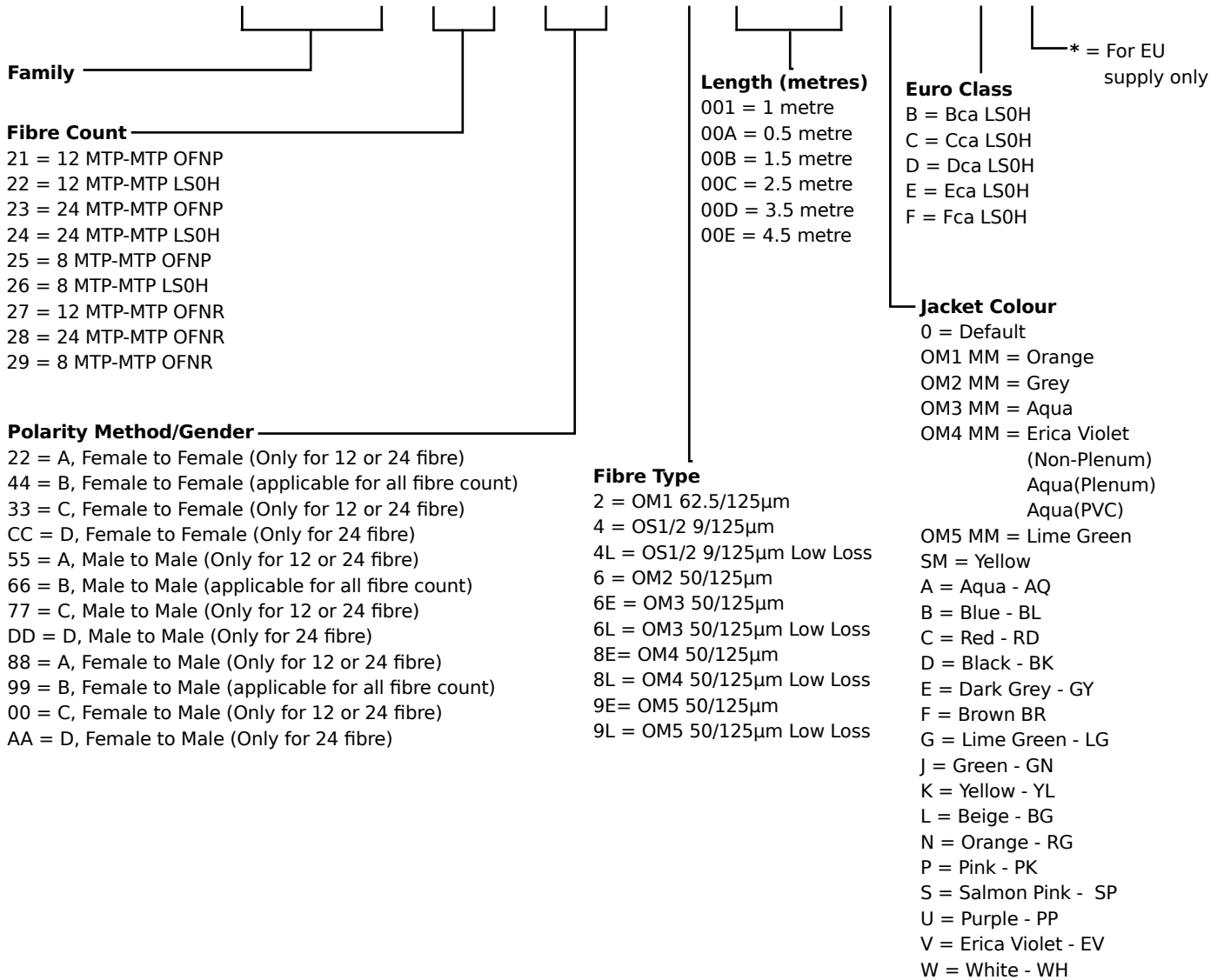

For Example: To order a 12 Core MTP-MTP Cable Assembly, Polarity A, Female to Female, OM1 62.5/125UM - OFPN yellow ModLink Cable, the part number would be 91-X2122-2100

Pre-Terminated Solutions

ModLink™ Fibre

Plug & Play



Hybrid Pre-Terminated Cable Assemblies
Molex Pre-Terminated Fibre Optic Cable Assemblies offer premium factory-controlled optical performance on a variety of connectors that enable fast, economical installation.

Pre-Terminated Cable Assemblies are ideal for mission-critical backbone applications such as Data Centre tie cables and low optical loss backbone riser cables.

- Available in:
 - Low Loss: OS1/2, OM3 and OM4 (Aqua or Erica Violet)
 - Standard Loss: OS1/2, OM1, OM2, OM3 and OM4 (Aqua or Erica Violet)
- 12-144 core count available with 12 or 24 cores MTP connector
- 2mm ruggedised tails and 900µm tails available
- Customised Tail Length and Configuration options available
- LSOH and OFNP cable jacket
- ROHS Compliant
- Ideal for: Internal short optical links
Front panel/equipment connections
Data centre infrastructure
Storage Area Network (SAN)
- Available with a variety of connector types

Part No. Matrix - Substitute the correct code number or letter to determine the assembly construction

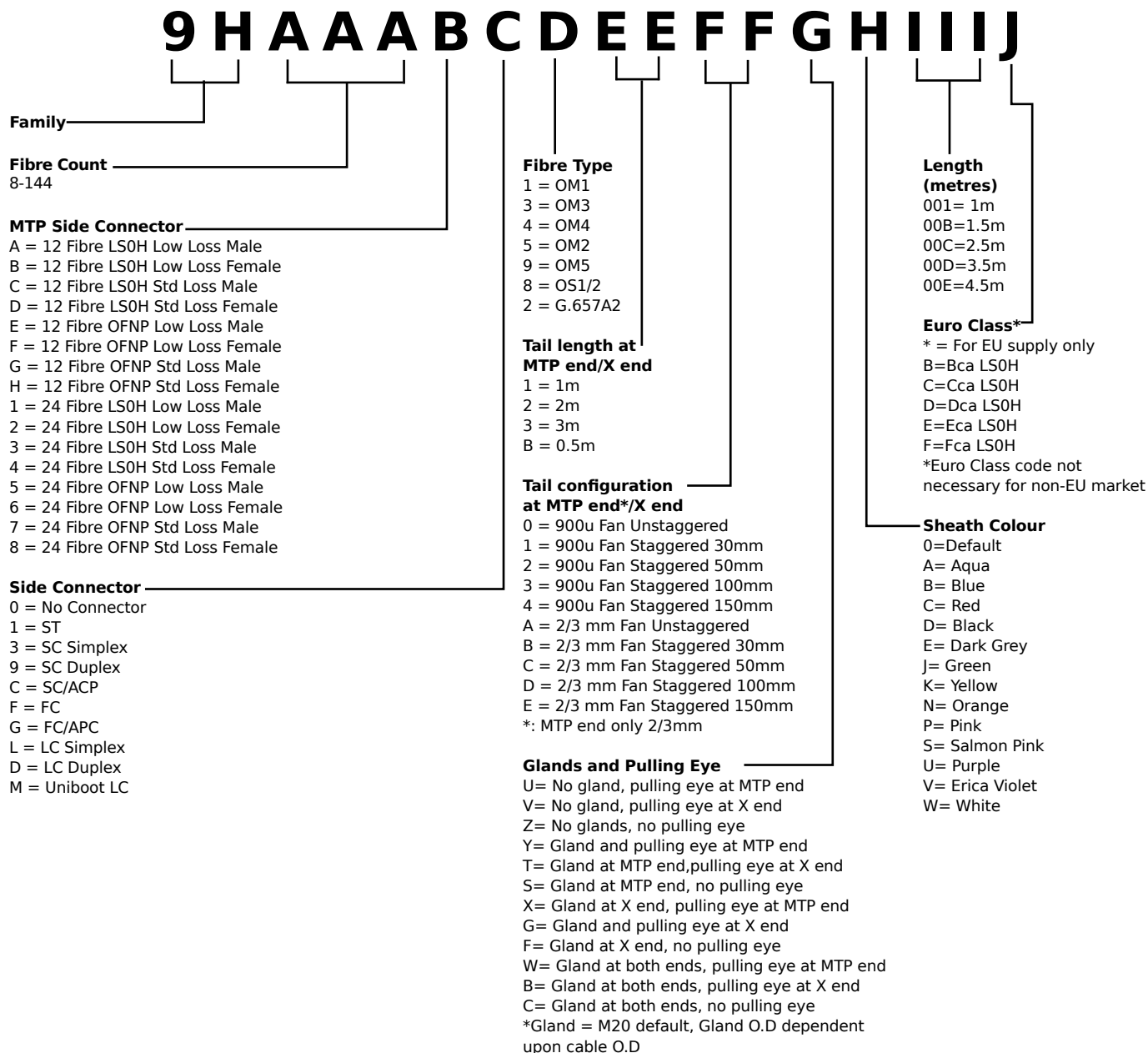

Pre-Terminated Solutions

ModLink™ Fibre

Plug & Play



MTP-MTP Pre-Terminated Multicore Cable Assemblies

- Available in Low Loss OS1/2, OM3 and OM4 (Aqua or Erica Violet) or standard Loss available OS1/2, OM1, OM2, OM3 and OM4 (Aqua or Erica Violet)
- 12 and 24 cores standard (high core counts up to 144 fibres available)
- 2mm ruggedised tails and 900µm tails available

- Customised Tail Length and Configuration options available
- LSOH and OFNP cable jacket
- RoHS Compliant
- Ideal for: Internal short optical links Front panel/equipment connections, Data centre infrastructure, Storage Area Network (SAN)

Part No. Matrix - Substitute the correct code number or letter to determine the assembly construction

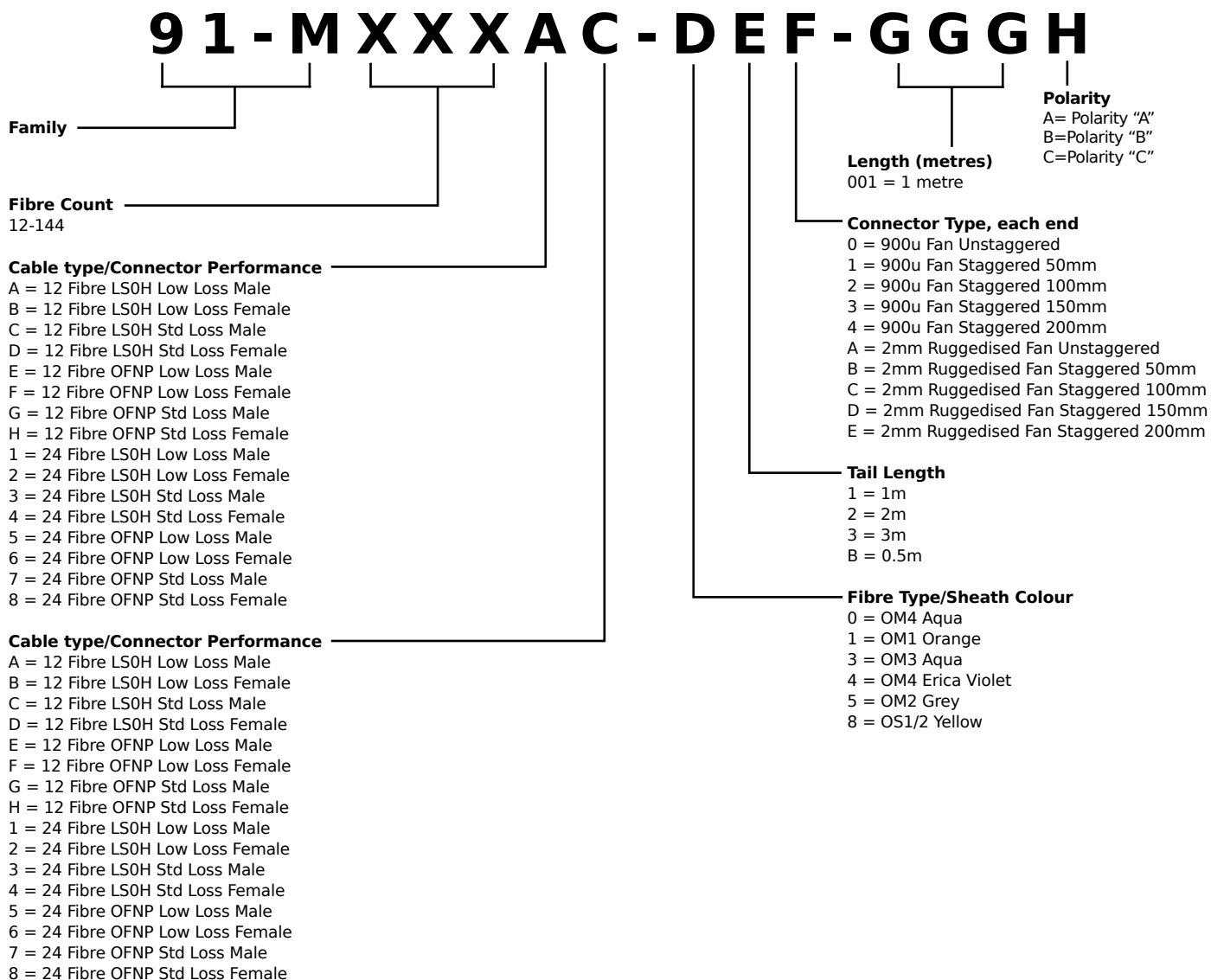

For Example: To order a 12 Core MTP Loss Loss Male Connector/MTP in OM3 Aqua LSOH Cable with 1m Tails in 900um Fan Unstaggered, 10 Metre Length, Polarity A the part number would be 91-M012AA-310-010A
 Standard Colours: OS1/2 = Yellow, OM1 = Orange, OM2 = Grey, OM3 = Aqua, OM4 = Erica Violet and Aqua (US Market)
 Cable Construction: 1-48 Core Micro Cable, 48+ = Loose Tube

Disruption in the work area Simply Solved >



Consolidation points offer a flexible solution enabling the fundamental change of a network installation without re-terminating. The zone based approach of consolidation points significantly reduces installation time and disruption in the work area, whilst enabling faster repair in the event of a problem.



Consolidation Points

Fibre Consolidation Point Enclosures

Molex consolidation points allow horizontal workplace cable to be terminated under a floor or above a ceiling in a protected enclosure - affording greater flexibility and usability. Consolidation points provides up to 12 fibre core capacity and feature Molex's unique shutter technology to protect the fibres from dust ingress.



PowerCat Consolidation Point Enclosures

PowerCat Consolidation Point Enclosures feature 6 or 8 shuttered Category 5e modules. Housed in a steel enclosure, incoming cable is protected, but allows ready access to the Consolidation Point to Telecommunication Outlet Links. Designed for easy installation in ceiling voids or under floor, the product is TIA/EIA TSB75 compliant.



MMI Enclosure

MMI Enclosure is a wall mounted unit for storing and protecting optical fibre.



Consolidation Points



Fibre Consolidation Point Enclosures

Molex consolidation points allow horizontal workplace cable to be terminated under a floor or above a ceiling in a protected enclosure - affording greater flexibility and usability. Consolidation points provides up to 12 fibre core capacity and feature Molex's unique shutter technology to protect the fibres from dust ingress.

- RoHS compliant
- Available in Singlemode & Multimode versions
- Shuttered adapters to protect against dust ingress
- Quarter turn fasteners used to secure lid
- Fibre jacket and strength member retention features fitted

Order No.	SAP No.	Description
CPT-00028	Consult Molex	12 Port Shuttered LC Consolidation Point, Singlemode
CPT-00029	Consult Molex	12 Port Shuttered MT-RJ Consolidation Point, Singlemode/Multimode
CPT-00030	0180080066	12 Port Shuttered Duplex SC Consolidation Point, Singlemode
CPT-00031	180080064	12 Port Shuttered Duplex SC Consolidation Point, Multimode
Accessories		
CPT-00034	0180080059	Consolidation Point Enclosure Base - Unloaded
CPT-00044	180080077	6 Port Consolidation Point Enclosure LC Plate, Singlemode
CPT-00041	180080074	6 Port Consolidation Point Enclosure MT-RJ Plate, Singlemode/Multimode
CPT-00042	180080075	6 Port Consolidation Point Enclosure SC Plate, Singlemode
CPT-00043	180080076	6 Port Consolidation Point Enclosure SC Plate, Multimode



PowerCat Consolidation Point Enclosures

PowerCat Consolidation Point Enclosures feature 6 or 8 shuttered Category 5e modules. Housed in a steel enclosure, incoming cable is protected, but allows ready access to the Consolidation Point to Telecommunication Outlet Links. Designed for easy installation in ceiling voids or under floor, the product is TIA/EIA TSB75 compliant.

- Allows moves, adds and changes without re-terminating and re-testing of cable
- Provides Category 5e performance
- 6 Port & 8 Port Versions Available
- Protected labelling facility
- 568 A/B wiring configuration
- Two enclosures may be interconnected, allowing for expansion

Order No.	SAP No.	Description
CPT-00022	180080070	6 Port PowerCat Consolidation Point Enclosure UTP 568A/B - Graphite Grey
CPT-00023	0180080063	8 Port PowerCat Consolidation Point Enclosure UTP 568A/B - Graphite Grey
Accessories		
CPT-00038	180080072	Consolidation Point Enclosure Plate - 8 Port



PowerCat 6A Consolidation Point Enclosure MUTO

Consolidation Points or Multi-User Telecommunications Outlets (MUTO) are intended to provide increased flexibility and economy for installations where open office spaces require frequent re-configuration.

- Allows moves, adds and changes without re-terminating and re-testing of cable
- 8 port capacity
- Rugged enclosure
- Factory assembled
- PowerCat 6A Shielded DataGate Modules included
- RoHS compliant

Order No.	SAP No.	Description
CPT-00053	0180080078	PowerCat 6A 8 Port Consolidation Point Enclosure, Shielded



MMI Enclosure

■ Wall mounted units for storing and protecting optical fibre
 ■ Holds 1.5m of up to 12 fibres with 900 micron buffers
 ■ Accepts up to six USO II fascias, enabling Category 5e or Category 6 performance

- Modules sold separately
- MMI-R provides rugged metal cover protection
- Accommodates ST, SC, MT-RJ & LC Euromod 25 x 50mm and 50 x 50mm Angled Fibre Modules
- Accommodates PowerCat Euromod modules

Order No.	SAP No.	Description
WFR-00016-01	0180970023	MMI-Plastic Cover - Almond
WFR-00016-02	0180970024	MMI-Plastic Cover - White
WFR-00016-08	0180970025	MMI-Plastic Cover - Light Grey
WFR-00017	0180970021	MMI-R-Metal Cover - Graphite Grey
WFR-00048	Consult Molex	12 Fibre Multimedia Tamper Proof Enclosure - Red
WFR-00048-WH	Consult Molex	12 Fibre Multimedia Tamper Proof Enclosure - White
WFR-00054-0C	Consult Molex	24 Fibre Multimedia Tamper Proof Enclosure - Red
WFR-00054-02	Consult Molex	24 Fibre Multimedia Tamper Proof Enclosure - White



Fibre Modules
Page 68

Angled Modules
Page 68

Euromod Modules
Page 29



Connecting Data >
Connecting Users
Delivering Customers

molex[®]

Managing your wiring closet Simply Solved >



Cable Management is an important part of any installation. Combining aesthetics with functionality, the Molex range of rack mountable cable management products offer cable management with minimal effort, ensuring long term manageability of the wiring closet.



Cable Management Solutions

Cable Management Solutions



Open Bay Rack



Cable Management Rings



Rack Manager

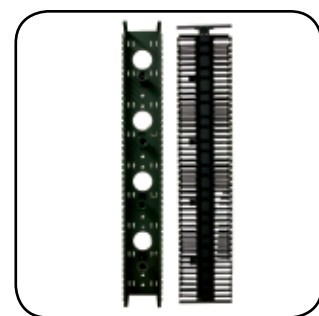

Cable Management Solutions

Cable Management is an important part of any installation. Combining aesthetics with functionality, the Molex range of rack mountable cable management products offer cable management with minimal effort, ensuring long term manageability of the wiring closet.



Ring Run Panels

- Available in various ring sizes for different cable densities
- Standard 19" rack mount 1U and 2U panels
- Styling complements Molex Patch Panel range
- Robust construction to handle harsh treatment
- Flexible rings for convenient operation
- Rounded edges to prevent damage to patch cords

1U Order No.	SAP No.	2U Order No.	SAP No.	Description
25.B016G	0180320002	25.B013G	0180320001	Ring Run
25.B035G	0180320007	25.B058G	0180320008	Deep Ring Run
25.AB18G	Consult Molex	25.B019G	Consult Molex	Blank Panels
25.A029G	Consult Molex	-	Consult Molex	Cable Brush Tidy
25.C001G	Consult Molex	-	Consult Molex	Panel 1U with cover

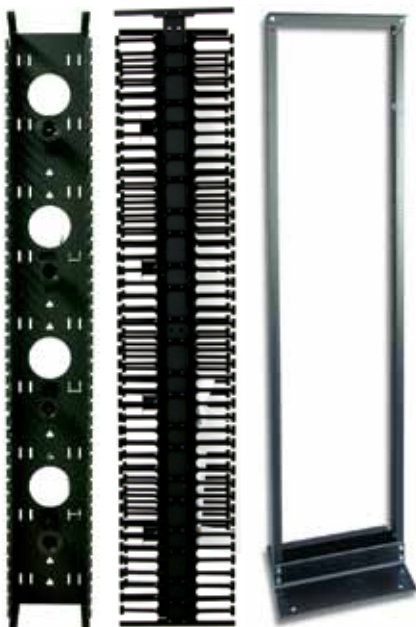

Vertical Rack Manager (VRM)

Used in conjunction with the Molex 45U, 19 inch Open Bay Rack, or equivalent, the VRM provides a robust and efficient way of managing cables and patch cords. It's ergonomic design ensures the necessary support for bundled patch cords, moving them from panels to the frame, maintaining bend radii at all times. Cable routing is flexible, and rapid re-routing can be achieved via the Quick Fit cable spools. Quick snap finger grooves enable flexible equipment management, and allow for expansion from 1U to whatever size required.

- Fits EIA standard 19" open bay racks
- Allows for upgrading current installations while maintaining current investment in hardware
- Maximises building Infrastructure
- Excels in space utilisation freeing up valuable floor space
- Strong & flexible poly carbonate finger guides
- Robust construction perfectly aligns cables, maintaining critical bend radii
- Snap grooved finger guides allow easy modification to 2/3U configuration
- Replacement finger guides ensures ongoing flexibility for future fit-out requirements
- Cable retainers click on to the end of finger guides, ideal for holding cables horizontally in place during maintenance
- Quick lock door allows for fast easy access with instantaneous left or right door opening with flush mounted handles
- Quick fit spool for easy single handed fit and removal of spools saving time and effort
- The design allows flexibility in fit out with additional spools and door kits available



Order No.	SAP No.	Description
CMA-00083	0181050000	12" Vertical Rack Cable Manager - Front/Back & Front Door
CMA-00084	0181050001	8" Vertical Rack Cable Manager - Front/Back & Front Door
CMA-00085	0181050006	1U Horizontal Cable Manager
CMA-00087	0181050006	2U Horizontal Cable Manager
CMA-00088	0181050012	12" Vertical Cable Retainer - 5 Pack
CMA-00089	0181050013	Spools - 2 Pack
CMA-00090	0181050014	Finger Guides - 5 Pack
CMA-00091	0181050015	12" Door Kit
CMA-00092	0181050016	8" Door Kit
CMA-00096	0181050017	8" Vertical Cable Retainer - 5 Pack
RAA-00002	180310026	Open Bay Rack



2U Horizontal Cable Manager



Cable Retainer



Spools



Connecting Data >
Connecting Users
Delivering Inspiration

Multi-media connectivity Simply Solved >



Additional solutions from Molex to enhance your connectivity, providing voice termination cabling to multi-media audio & video modules.



Additional Solutions

Voice

The Molex Voice Solution provides a range of products to allow the termination of dedicated voice cabling in a structured cabling environment. The range includes 50 Port Voice panels, Telco Panels and Line Adapter Units. The range also offers a cost effective and simple way to feed PBX or other voice circuits into an installation.



Outlet Configurations

Molex provide a vast range of outlet mounting platforms covering wallplates and surface mount boxes. Our range has been designed to allow the fitment of industry standard RJ-45 products as well as our modular Synergy/DataGate foot print. The Molex Synergy foot print allows a modular fit out at the outlet. With modules that cover C5E, C6, C6A and audio/visual as well as optical fibre, Molex is able to deliver an integrated communications suite.

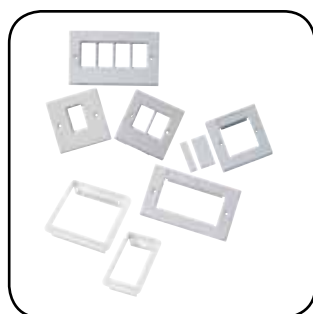

Media Outlets

Frequently, the need arises to integrate multiple media types within the one cabling system. It is becoming common for example for UTP, fibre optics, audio and video media to be used in the same environment.

To support these situations, Molex has designed a range of wiring closet and work area products, which accommodate UTP, fibre optics, audio and video media types using modular designs.



Voice and Telco Solutions



50 Port Voice Panel

The 50 Port 1U Voice Panels are a cost-effective product range designed to utilise the minimum of rack/cabinet space to support 2, 25 or 50 pair cables in a voice backbone.

Supporting two or three pair connectivity for analogue or digital telephone services, the panels feature logical port numbering for easy configuration of the pairs (3-6, 4-5), using dual colour coded (568A/B) KATT IDC connectors. 19" rack mountable, the panel features an integral rear management tray.

- 50 Port 1U
- Category 3 compliant
- Integral cable management tray
- 19" rack mountable
- Full range of Telco cable assemblies available

Order No.	SAP No.	Description
PID-00145	0182040013	50 Port Voice Panel RJ45 UTP 1U - Pairs 3/6, 4/5

Disconnect and Connection Modules

Both disconnect and connection type modules are available for all voice applications, markets and regulatory requirements. The modules accommodate up to 10 pairs in a small footprint, enabling high density interconnection facilities.

- Distribution of voice applications
- Module is available in disconnect and connection formats
- Standard 45° IDC contact
- Versatile can be used in indoor or outdoor applications
- Accepts cable diameter 0.4mm to 0.8mm
- Accommodates two wires
- Accepts KATT or LSA+ IDC tools
- RoHS Compliant



Order No.	SAP No.	Description
DCN-00001P	0182030022	10 Pair Disconnect Module Clip On
DCN-00002	0182030002	10 Pair Connection Module

Category 3 Multi-pair U/UTP Cable

Molex 25, 50 and 100 pair Category 3 cable has been designed to support telephony voice wiring applications. The cable has been designed and tested in accordance with UL 444, EIA/TIA568 & ISO/IEC 11801 standards.

- Supports telephony voice wiring applications
- 25, 50 and 100 pair Cable
- LSOH Sheaths
- Colour coded pairs for ease of termination
- Compliant with EN 50575:2014+A1:2016 EU Reaction to Fire Performance criteria



Order No.	SAP No.	Description
CAA-00344	Consult Molex	Category 3 50 Pair LSOH Eca cable - 2km reel
CAA-00346	Consult Molex	Category 3 100 Pair LSOH Eca cable - 2km reel
CAA-00380	Consult Molex	Category 3 25 Pair LSOH Eca cable - per metre
CAA-00382	Consult Molex	Category 3 50 Pair LSOH Eca cable - per metre

Outlet Configuration Solutions



Euromod™ and MOD-SNAP™ Wallplates and Blanks

The Euromod and MOD-SNAP wallplate systems provide a flexible and versatile method of installation. Available in single and double gang versions the wallplates are designed to accept Euromod (25 x 50mm fascia) and MOD-SNAP (38.5 x 25mm fascia) modular ranges.

- Euromod - 50 x 50mm single gang
50 x 100mm double gang
- Euromod snap-in collar - 1 port & 2 port
- MOD-SNAP - 38.5x25mm aperture - 1, 2 & 4 port
- Flexible system allowing the installation of as many modules as required

Order No.	SAP No.	Description
17-0111-02	180060058	Labelled Single Gang Euromod Wallplate - 86 x 86 x 10mm
17-0112-02	181390002	Labelled Double Gang Euromod Wallplate - 86 x 145 x 10mm
17-0231-02	Consult Molex	Euromod Snap-in Adapter Collar (half) 25mm x 50mm
17-0232-02	Consult Molex	Euromod Snap-in Adapter Collar (full) 50mm x 50mm
42-311-02	0181400006	Single Gang MOD-SNAP 1 Aperture - 86 x 86mm
42-312-02	0181400005	Single Gang MOD-SNAP 2 Aperture - 86 x 86mm
42-314-02	0181400008	Double Gang MOD-SNAP 4 Aperture - 86 x 146mm
17-0412-02	0180060060	Euromod Quarter (12.5 x 50mm) Blank - White
17-0413-02	0180060061	Euromod Half (25 x 50mm) Blank - White
17-0414-02	0180060062	Euromod Full (50 x 50mm) Blank - White
MMS-00014-**	Consult Molex	MOD-SNAP Module Blank



Keystone Jack Wall Plates and Module Fascia

Euromod™ Keystone Jack Fascia 25 x 50mm Unloaded.

The unloaded Euromod Keystone Fascia is specifically designed to accept the Molex Keystone Jack product range. The angled design reduces bend cord radius particularly in shallow floor box installations. The fascia is supplied with an integral spring loaded shutter for dust protection and a labelling window facility. The white Euromod Keystone Jack fascia is designed to fit into the white single gang (86 x 86mm) and double gang (86 x 145mm) wall plates, which are manufactured from the same colour matched material

- Integral spring loaded shutter
- Protected labelling facility
- RoHS compliant
- 25 x 50mm angled fascia
- Compatible with Keystone Jacks
- Matching single and double gang wall plates

Order No.	SAP No.	Description
MEU-00073-02	181770332	Euromod Keystone Jack Fascia, 25 x 50mm, unloaded - white
MEU-00071-02	181770333	Euromod Keystone Jack Fascia Wall Plate, Single Gang 86 x 86mm - white
MEU-00072-02	181770334	Euromod Keystone Jack Fascia Wall Plate, Double Gang 86 x 1456mm - white



Keystone Jack Fascia 22.5 x 45mm Unloaded

The unloaded 22.5 x 45mm Keystone Fascia is specifically designed to accept the Molex Keystone Jack product range. The angled design reduces patch cord bend radius. The fascia is supplied with an integral spring loaded shutter for dust protection and a labelling window facility. The product is compatible with Legrand Mosaic™ wall plates (not supplied).

- Integral spring loaded shutter
- Protected labelling facility
- RoHS compliant
- 22.5 x 45mm angled fascia
- Compatible with Legrand Mosaic wall plates
- Compatible with Keystone Jacks

Order No.	SAP No.	Description
MLG-00037-02	0181770331	Keystone Jack Fascia, 22.5 x 45mm, unloaded - white

Outlet Configuration Solutions



Contura™ Wallplates

The Molex Contura modular wall outlet range was designed to combine aesthetics with functionality. The contemporary design of the products is ideal for the modern office and provides the user with the flexibility of installing as many modules as required. Contura wallplates are available as either single or double gang wallplates with a grid-plate and are designed to accept the Contura 50 x 22mm module.

- Contemporary design
- Single and double gang wallplates
- Single gang - 86 x 86mm - external
50 x 45mm - internal aperture
- Double gang - 86 x 145mm - external
50 x 90mm - internal aperture

Order No.	SAP No.	Description
WGB-00001-02	181770083	Single Gang wallplate (includes grid plate) - White
WGB-00002-02	181770084	Double Gang wallplate (includes grid plate) - White
MGB-00002-02	181770216	Contura Module Blank - White

** Colour Options - 02 = White 04 = Black



CSP-00021



CSP-00022



CSP-00023

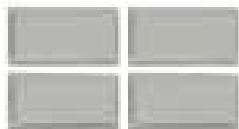

Wallplate label holders and Labels

Label Kits

Order No.	SAP No.	Description
35-X002	Consult Molex	Label holder and label pack (100) for Euromod/MOD-SNAP C5e
35-X003	Consult Molex	Label holder and label pack (250) for Euromod Wallplate
35-X004	Consult Molex	Label holder and label pack (100) for C5e Fixed Wallplates
CSP-00031	Consult Molex	Label holder and label pack (20) for DataGate modules
CSP-00038	Consult Molex	Label holder and label pack (100) for Synergy Wallplates and Surface boxes
CSP-00021-**	Consult Molex	Blank Connector Icon Labels 6-Pack
CSP-00022-**	Consult Molex	Data Connector Icon Labels 6-Pack
CSP-00023-**	Consult Molex	Voice Connector Icon Labels 6-Pack

** Colour Options - 01 = Almond, 02 = White, 04 = Black, 05 = Ivory, 08 = Light Grey, RD = Red, BL = Blue, GR = Green, YL = Yellow, RG = Orange, PP = Purple



Mod-Snap Keystone Jack Fascia 38.5 x 25mm unloaded

The unloaded Mod-Snap Keystone Fascia is specifically designed to accept the Molex Keystone Jack product range. The angled design reduces bend cord radius particularly in shallow floor box installations. The fascia is supplied with an integral spring loaded shutter for dust protection and a window labelling facility. The product is compatible with the Mod-Snap wall plate range. Part numbers of compatible wall plates are shown below.

- Integral spring loaded shutter
- Protected labelling facility
- RoHS compliant
- 38.5 x 25mm angled fascia
- Compatible with Keystone Jacks

Order No.	SAP No.	Description
MMS-00020-02	1817703302	Mod-Snap Keystone Jack Fascia, 38.5 x 25mm, unloaded - white

Outlet Configuration Solutions



Contura™ Wallplate

- Single Gang Wallplate: 86mm x 86mm
- Double Gang Wallplate: 86mm x 145mm

- Available in white only
- Flexible and versatile method of installation
- Accommodates Contura modules



Contura Modules
Page 18

Order No.	SAP No.	Description
WGB-00001-02	0181770083	Contura Single Gang Wallplate (includes grid plate), White - Unloaded
WGB-00002-02	0181770084	Contura Double Gang Wallplate (includes grid plate), White - Unloaded
MGB-00002-02	0181770216	Contura Blank Module - White



Euromod™ Wallplates

- Three Port 71mm x 114mm aperture size
- Single Gang 50mm x 50mm aperture size
- Double Gang 50mm x 100mm aperture size
- Low profile design

- Available in white only
- Flexible and versatile method of installation
- Available with or without labelling facility
- Accommodates Euromod modules



Euromod Modules
Page 27

Order No.	SAP No.	Description
17.C0012	0181770001	Unlabelled Three Port Euromod Wallplate, 114mm x 71mm x 9mm - Unloaded
17-0101-02	Consult Molex	Euromod Single Gang Wallplate, 50mm x 50mm, No Labelling Facility
17-0102-02	Consult Molex	Euromod Double Gang Wallplate, 50mm x 100mm, No Labelling Facility
17-0111-02	0180060058	Euromod Single Gang Wallplate, 50mm x 50mm, Labelling Facility
17-0112-02	0181390002	Euromod Double Gang Wallplate, 50mm x 100mm, Labelling Facility
17-0412-02	0180060060	Euromod Quarter (12.5 x 50mm) Blank - White
17-0413-02	0180060061	Euromod Half (25 x 50mm) Blank - White
17-0414-02	0180060062	Euromod Full (50 x 50mm) Blank - White



MOD-SNAP™ Wallplates

- Single Gang Wallplate: 50mm x 50mm
- Double Gang Wallplate: 50mm x 100mm

- Available in white only
- Flexible and versatile method of installation
- Accommodates MOD-SNAP modules



MOD-SNAP Modules
Page 27

Order No.	SAP No.	Description
MMS-00014-02	Consult Molex	MOD-SNAP Blank Module - White
42-311-02	0181400006	MOD-SNAP Single Gang, Single Aperture, 86mm x 86mm - Unloaded
42-312-02	0181400005	MOD-SNAP Single Gang, Double Aperture, 86mm x 86mm - Unloaded
42-314-02	0181400008	MOD-SNAP Double Gang, 4 Aperture, 86mm x 146mm - Unloaded

Media Outlet Solutions



DIN 49075 Keystone Jack Fascia & Bezel 2 Port 50 x 50mm unloaded

The unloaded DIN 49075 2 Port Keystone Fascia is specifically designed to accept the Molex Keystone Jack product range. The angled design reduces bend cord radius. The fascia is supplied with integral shutters for dust protection and a labelling window facility. The fascia includes a 50 x 50mm outer bezel.

- 50 x 50mm angled fascia with bezel
- Integral shutters
- Protected labelling facility
- RoHS compliant
- Compatible with Keystone Jacks

Order No.	SAP No.	Description
WNC-00052-02	0181770335	DIN 49075 Keystone Jack Fascia 2 Port with Bezel, unloaded - white

Audio & Video Modules

Audio and Video modules are versatile modules for unique applications where pre-connectorised cables must be mated. Single Position Modules fit into Molex's configurable panels and wallplate systems that accept Molex's DataGate™ jack.

- Enables line extensions for legacy cabling systems
- Single Position Modules are designed to fit into Molex's Synergy™ & USO II™ system of wallplates and surface blocks



MUS-00096-0*

MUS-00097-0*

Order No.	SAP No.	Description
MSY-00002-0*	Consult Molex	Single Position F Video Module
MSY-00032-0*	Consult Molex	Single Position S Video Coupler Module
MSY-00033-R*	Consult Molex	Single Position RCA Coupler Red Module
MSY-00033-W*	Consult Molex	Single Position RCA Coupler White Module
MSY-00033-Y*	Consult Molex	Single Position RCA Coupler Yellow Module
MSY-00036-0*	Consult Molex	Single Position BNC Coupler Module
Accessories		
MUS-00096-0*	Consult Molex	1 Port Fascia (Bag of 10) - 25 x 50mm
MUS-00097-0*	Consult Molex	2 Port Fascia (Bag of 10) - 25 x 50mm
MUS-00185	Consult Molex	Blank Module (Bag of 10) - 25 x 50mm
KSJ-00005-0*	Consult Molex	Single Position Blank Module (Bag of 25)

* Colour Options - 1 = Almond, 2 = White, 5 = Ivory, 4 = Black, 8 = Light Grey

WM-12

The WM-12 is a wall-mounted steel enclosure that provides up to 18 fibre ports in a minimum of space. The WM-12 has an integral configurable panel that accepts up to six Euromod modules.

Modules may be mixed for UTP, FTP, optical fibre and coax, making it the most versatile and compact wall mount enclosure for mixed media. Its design also guarantees that all of the media will be protected and proper fibre bend radius is maintained.

- Up to 18 fibre ports
- Fully configurable using Molex's Euromod modules
- Available with fully lockable steel doors when security is a primary concern



Fibre Modules
Page 68

Euromod Modules
Page 27

Order No.	SAP No.	Description
WFR-00018	0180090008	WM12 - Graphite Grey

Media Outlet Solutions



Multi User Telecommunications Outlet (MUTO)

The Multi User Telecommunications Outlet (MUTO) is the ideal solution for high-density fibre or copper requirements in the office environment. This sleek product holds up to twelve 25 x 50mm Euromod Modules or USO II fascias and is easily mounted near file servers, active devices, and workstations. The MUTO can also accommodate up to six 50 x 50mm Angled Fibre Modules.

- Aluminium main body
- Two metal end caps (angled)
- Two plastic end caps (flat)
- Four end cap screws
- Two plastic end plugs (for metal end caps)
- Two Snapz™ icon trees (alpha)
- Accommodates 25 x 50mm USO II fascias, enabling Category 5e or Category 6 performance
- Accommodates ST, SC, MT-RJ & LC Euromod 25 x 50mm and 50 x 50mm Angled Fibre Modules



Order No.	SAP No.	Description
CPT-00004	0180080020	Multi User Telecommunications Outlet (MUTO)

Installation equipment Simply Solved >



Molex offers a range of tools and testers to aid installation of copper and fibre systems.



Tools & Testers

Termination Tools

Installation starts with having the right tool, the Molex terminations tools offer faultless termination for either Datagate 4 or Category 6 systems.

Testers

Standards have changed throughout the years but there has been one constant. Molex's range of continuity testers - is the mainstay of any installer's toolkit. This industry favourite, known for its long life and reliable performance is still available.



Tools and Testers

Molex offers a range of tools and testers to aid installation of copper and fibre systems.



DataGate™ 4 Pair Termination Tool

The Molex DataGate 4 Pair Termination Tool is a robust and reliable product that offers faultless gas-tight terminations of all four pairs simultaneously. The tool frame is manufactured from high grade steel with die-cast termination heads. Designed specifically for use with Molex DataGate and Keystone style jacks, the 4 Pair Termination Tool Frame is supplied unloaded into which either the UTP Termination Head (for termination of the UTP DataGate and Keystone jacks) or the C6A Termination Head (for termination of the C6A shielded DataGate jacks) is fitted.

Operation is uncomplicated and efficient. The jack is placed over the four cables that have been securely seated in the Termination Head. The Termination Head and jack are then pivoted into the cutting position and the handles depressed, resulting in cables that are firmly and accurately seated and neatly trimmed, in one simple operation.

- Designed specifically for the DataGate, Keystone and C6A Shielded Jacks
- Simple to operate
- Cables are terminated and neatly trimmed in one operation
- Tool Frame supplied unloaded. UTP and C6A Termination Heads supplied separately
- MOD-Clip 4 Pair Termination Tool is compatible with UTP MOD-Clip C6 Jacks only. C6A MOD-Clip jacks are terminated using the DataGate tool

Order No.	SAP No.	Description
31.0011	Consult Molex	4 Pair Termination Tool Frame
31.0010	Consult Molex	4 Pair Termination Tool Frame, UTP - MOD-Clip Jack only
31.0012	Consult Molex	Termination Head UTP
31.0013	Consult Molex	Termination Head C6A



Termination Tools & Terminating Puck

The Category 6 110 Style Multi-Pair Termination Tool provides 4-pair high impact termination specifically for Molex 110 Style Category 6 Connector termination.

The IDC Punchdown Tool provides reliable terminations and is compatible with 110 Style.

The Punch-Down Terminating Puck is a handy twisted pair termination aid that works with Molex RJ45 DataGate jacks.

Order No.	SAP No.	Description
KPD-00087	0181980070	Category 6 110 Style Multi-Pair Termination Tool with Head and Handle
31-001	0180380001	110 Punchdown Termination Tool
CSP-00018-04	180400053	Punchdown Terminating Puck (Black)

SLT3S™ Tester

The SLT3S Tester is a rugged, lightweight product designed to verify the integrity of 1, 2, 3, and 4 pair UTP and FTP channels. Incorporating a unique 3-in-1 design, this tester features built-in modular jacks for USOC, EIA 568A and 568B wiring sequences.

Simply connect the master and slave unit to each end of the cable under test, and the SLT3S automatically verifies correct cable sequence, as well as open and short circuits.

- Innovative 3-in-1 design features modular jacks for testing USOC, EIA 568A and 568B cabling systems
- Accurately verifies the continuity and sequence of 1, 2, 3 and 4 pair UTP and FTP channels
- Continuously-sequencing LED display provides a diagnostic readout that immediately detects shorts, opens, reversals and mis-wires at a glance



Order No.	SAP No.	Description
33A-100-10	0180390011	SLT3S Tester (Master and Slave Units) with 9 Volt battery

Order No. Reference

Order No.	SAP No.	Description	Page	Order No.	SAP No.	Description	Page
31.001	Consult Molex	4 Pair Termination Tool Frame, UTP - MOD-Clip Jack only	94	17-0102-02	Consult Molex	Euromod Double Gang Wallplate, 50mm x 100mm, No Labelling Facility	89
31.0011	Consult Molex	4 Pair Termination Tool Frame	94	17-0111-02	180060058	Labelled Single Gang Euromod Wallplate - 86 x 86 x 10mm	87
31.0012	Consult Molex	Termination Head UTP	94	17-0111-02	180060058	Euromod Single Gang Wallplate, 50mm x 50mm, Labelling Facility	89
31.0013	Consult Molex	Termination Head C6A	94	17-0112-02	181390002	Labelled Double Gang Euromod Wallplate - 86 x 145 x 10mm	87
106123-0200	1061230200	Quad LC Singlemode OS1/2 Shuttered Adapter - Blue	65	17-0112-02	181390002	Euromod Double Gang Wallplate, 50mm x 100mm, Labelling Facility	89
106123-1200	1061231200	Quad LC Multimode OM1/2 Shuttered Adapter - Beige	65	17-0231-02	Consult Molex	Euromod Snap-in Adapter Collar (half) 25mm x 50mm	87
106123-3200	1061233200	Quad LC Multimode OM3 Shuttered Adapter - Aqua	65	17-0232-02	Consult Molex	Euromod Snap-in Adapter Collar (full) 50mm x 50mm	87
106127-0310	1061277030	Duplex LC Multimode OM1/2 Shuttered Adapter - Beige	65	17-0412-02	180060060	Euromod Quarter (12.5 x 50mm) Blank - White	30
106127-0350	Consult Molex	LC-LC Shuttered Duplex MM OM3 Phosphor Bronze Flange Mount - Aqua	63	17-0412-02	180060060	Euromod Quarter (12.5 x 50mm) Blank - White	87
106127-0350	1061270350	Duplex LC Multimode OM3 Shuttered Adapter - Aqua	65	17-0412-02	180060060	Euromod Quarter (12.5 x 50mm) Blank - White	89
106127-0410	Consult Molex	LC-LC Shuttered Duplex MM OM1/OM2 Phosphor Bronze Snap Mount - Beige	63	17-0413-02	181370005	Euromod Half (25 x 50mm) Blank - White	30
106127-1300	1061271300	Duplex LC Singlemode OS1/2 Shuttered Adapter - Blue	65	17-0413-02	180060061	Euromod Half (25 x 50mm) Blank - White	87
106127-1300A	1061271300A	LC Shuttered Duplex, Singlemode, Zirconia Alignment	63	17-0413-02	180060061	Euromod Half (25 x 50mm) Blank - White	89
106127-1310A	1061271310A	LC Shuttered Duplex, Multimode, Phosphor Bronze Alignment	63	17-0414-02	180060062	Euromod Full (50 x 50mm) Blank - White	30
106127-1350	Consult Molex	LC-LC Shuttered Duplex SM OS1 Zirconia Ceramic Flange Mount - Green	63	17-0414-02	180060062	Euromod Full (50 x 50mm) Blank - White	87
106127-1400	Consult Molex	LC-LC Shuttered Duplex SM OS1 Zirconia Ceramic Snap Mount - Blue	63	17-0414-02	180060062	Euromod Full (50 x 50mm) Blank - White	89
106127-1450	Consult Molex	LC-LC Shuttered Duplex SM OS1 Zirconia Ceramic Snap Mount - Green	63	18262-0033	182620033	SC Oven Cure Connector MM Zirconia 900µm Beige Epoxy	64
106127-1610	Consult Molex	LC-LC Shuttered Duplex MM OM3 Phosphor Bronze Snap Mount - Aqua	63	18262-0034	182620034	LC Oven Cure Connector MM Zirconia 900µm Beige Epoxy	64
106166-0200	Consult Molex	SC Duplex Adapter Shutter - Blue	62	18262-0041	182620041	LC Oven Cure Connector SM Zirconia 900µm Blue Epoxy	64
106166-0210	Consult Molex	SC Duplex Adapter Shutter - Beige	62	18262-0043	182620043	SC Oven Cure Connector SM Zirconia 900µm Blue Epoxy	64
106166-0500A	Consult Molex	SC/SC Duplex SM Zirconia Flange Mount Shuttered - Blue	62	18282-0033	182820033	SC/SC Duplex MM Phosphor Bronze Flange Mount Unshuttered - Beige	62
106166-0550	Consult Molex	SC/SC APC Duplex SM Zirconia Flange Mount Shuttered - Green	63	18282-0034	182820034	SC/SC Duplex MM Phosphor Bronze Snap Unshuttered - Beige	62
106166-0600	Consult Molex	SC/SC Duplex SM Zirconia Snap Mount Shuttered - Blue	62	18282-0035	182820035	SC/SC Duplex MM Phosphor Bronze Flange Mount Unshuttered - Aqua	62
106166-0650	Consult Molex	SC/SC APC Duplex SM Zirconia Snap Mount Shuttered - Green	63	18282-0035	182620017	SC Multimode OM3 Unshuttered Adapter - Aqua	65
106167-0410	Consult Molex	SC/SC Duplex MM Phosphor Bronze Flange Mount Shuttered - Aqua	62	18282-0036	182820036	SC/SC Duplex MM Phosphor Bronze Snap Unshuttered - Aqua	62
106167-0510A	Consult Molex	SC/SC Duplex MM Phosphor Bronze Flange Mount Shuttered - Beige	62	18282-0037	182820037	SC/SC Duplex SM Zirconia Flange Mount Unshuttered - Blue	62
106167-0610	Consult Molex	SC/SC Duplex MM Phosphor Bronze Snap Mount Shuttered - Beige	62	18282-0038	182820038	SC/SC Duplex SM Zirconia Snap Mount Unshuttered - Blue	62
106167-0620	Consult Molex	SC/SC Duplex MM Phosphor Bronze Snap Shuttered - Aqua	62	18282-0039	182820039	SC/SC APC Duplex SM Zirconia Flange Mount Unshuttered - Green	63
106167-1000	1061671000	SC/ST Duplex, Singlemode, Phosphor Bronze, Flange Mount	62	18282-0040	182820040	SC/SC APC Duplex SM Zirconia Snap Mount Unshuttered - Green	63
106167-1010	1061671010	SC/ST Duplex, Multimode, Phosphor Bronze, Flange Mount	62	18282-0041	182820041	LC Unshuttered Duplex, MM, Flange Mount, Phosphor Bronze Alignment - Beige	63
106167-1100	1061671100	SC/ST Duplex, Singlemode, Phosphor Bronze, Snap Mount	62	18282-0041	182820041	Duplex LC Multimode OM1/2 Unshuttered Adapter - Beige	65
106167-1110	1061671110	SC/ST Duplex, Multimode, Phosphor Bronze, Snap Mount	62	18282-0042	182820042	LC Unshuttered Duplex, MM, Snap Mount, Phosphor Bronze Alignment - Beige	63
106167-1500	1061671500	SC/ST Shuttered Duplex, Singlemode, Phosphor Bronze, Flange Mount	62	18282-0043	182820043	LC Unshuttered Duplex, MM, Flange Mount, Phosphor Bronze Alignment - Aqua	63
106167-1510	1061671510	SC/ST Shuttered Duplex, Multimode, Phosphor Bronze, Flange Mount	62	18282-0043	182820043	Duplex LC Multimode OM3 Unshuttered Adapter - Aqua	65
106167-1600	1061671600	SC/ST Shuttered Duplex, Singlemode, Phosphor Bronze, Snap Mount	62	18282-0044	182820044	LC Unshuttered Duplex, MM, Snap Mount, Phosphor Bronze Alignment - Aqua	63
106167-1610	1061671610	SC/ST Shuttered Duplex, Multimode, Phosphor Bronze, Snap Mount	62	18282-0045	182820045	LC Unshuttered Duplex, SM, Flange Mount, Zirconia Alignment - Blue	63
16.A0012	180070055	22.5 x 45mm Blank Module - White	30	18282-0045	182820045	Duplex LC Singlemode OS1/2 Unshuttered Adapter - Blue	65
16.A0012	180070055	22.5 x 45mm Blank Module - White	33	18282-0046	182820046	LC Unshuttered Duplex, SM, Snap Mount, Zirconia Alignment - Blue	63
17.A0162	181210015	25 x 50mm Duplex SC Module, Multimode - 1 Adapter	66	18282-0047	182820047	LC Unshuttered APC Duplex, SM, Flange Mount, Zirconia Alignment - Green	63
17.A0172	181210014	25 x 50mm Duplex SC Module, Singlemode - 1 Adapter	66	18282-0048	182820048	LC Unshuttered APC Duplex, SM, Snap Mount, Zirconia Alignment - Green	63
17.A0182	182620006	25 x 50mm Duplex SC-ST Module, Multimode - 1 Adapter	66	18282-0049	182820049	Quad LC Multimode OM1/2 Unshuttered Adapter - Beige	65
17.A0192	182620007	25 x 50mm Duplex SC-ST Module, Singlemode - 1 Adapter	66	18282-0051	182820051	Quad LC Multimode OM3 Unshuttered Adapter - Aqua	65
17.A0202	184000467	25 x 50mm Shuttered Duplex SC Module, Multimode - 1 Adapter	66	18282-0053	182820053	Quad LC Singlemode OS1/2 Unshuttered Adapter - Blue	65
17.A0212	184000466	25 x 50mm Shuttered Duplex SC Module, Singlemode - 1 Adapter	66	18282-0057	182820057	ST Simplex SM/MM Zirconia P Bronze Double-D	65
17.A0222	182620008	25 x 50mm Shuttered Duplex SC-ST Module, Multimode - 1 Adapter	66	18282-0065	182820065	ST Simplex SM/MM Zirconia Metal Double-D	65
17.C0012	181770001	Unlabelled Three Port Euromod Wallplate, 114mm x 71mm x 9mm - Unloaded	89	18282-0089	182820089	LC Unshuttered Duplex MM OM4, Snap Mount, Zirconia Alignment - Erica Violet	63
17-0101-02	Consult Molex	Euromod Single Gang Wallplate, 50mm x 50mm, No Labelling Facility	89	18282-0090	182820090	SC Duplex MM OM4 Phosphor Bronze Snap Unshuttered - Erica Violet	62
				18282-0091	182820091	SC Duplex MM OM4 Phosphor Bronze Flange Mount Unshuttered - Erica Violet	62
				18282-0091	182820091	SC Multimode OM3 Unshuttered Adapter - Erica Violet	65

Order No. Reference

Order No.	SAP No.	Description	Page	Order No.	SAP No.	Description	Page
18282-0092	182820092	LC Unshuttered Duplex MM OM4, Flange Mount, Zirconia Alignment - Erica Violet	63	AFR-00118	180600042	6 Fibre Shuttered Duplex SC Adapter Plate, Singlemode	60
18282-0107	182820107	SC Duplex MM OM4 Zirconia Flange Mount Unshuttered - Erica Violet	62	AFR-00120	180600044	6 Fibre Shuttered Duplex SC Adapter Plate, Multimode	60
18282-0111	182820111	SC Duplex MM OM4 Zirconia Snap Mount Unshuttered - Erica Violet	62	AFR-00182	180600129	6 Fibre Angled Duplex SC Adapter Plate, Multimode	60
18282-0116	182820116	Duplex LC Multimode OM3 Unshuttered Adapter - Erica Violet	65	AFR-00182-EV	180600310	6 Fibre Angled Duplex SC Adapter Plate, OM4 MM - Erica Violet	60
18282-0126	182820126	Quad LC Multimode OM3 Unshuttered Adapter - Erica Violet	65	AFR-00183	180600116	6 Fibre Angled Duplex SC Adapter Plate, Singlemode	60
25.A029G	Consult Molex	Cable Brush Tidy	82	AFR-00185	180600131	6 Fibre Angled ST Adapter Plate, Singlemode	60
25.AB18G	Consult Molex	Blank Panels	82	AFR-00186	180600132	6 Fibre Angled Duplex SC-ST Adapter Plate, Multimode	60
25.B013G	180320001	Ring Run	82	AFR-00187	180600133	6 Fibre Angled Duplex SC-ST Adapter Plate, Singlemode	60
25.B016G	180320002	Ring Run	82	AFR-00190	Consult Molex	Low Profile 24 Fibre Fusion Splice	57
25.B019G	Consult Molex	Blank Panels	82	AFR-00200	180600093	ST/ST Duplex SM Zirconia Blue Flange	65
25.B035G	180320007	Deep Ring Run	82	AFR-00201	180600094	ST/ST Duplex MM P Bronze Beige Flange	65
25.B058G	180320008	Deep Ring Run	82	AFR-00202	182620013	Duplex SC Singlemode OS1/2 Unshuttered Adapter - Blue	65
25.C001G	Consult Molex	Panel 1U with cover	82	AFR-00203	182620013	Duplex SC Multimode OM1/2 Unshuttered Adapter - Beige	65
31-001	180380001	110 Punchdown Termination Tool	94	AFR-00222	180600069	Universal Splice Tray Carrier Kit	55
33A-100-10	180390011	SLT35 Tester (Master and Slave Units) with 9 Volt battery	94	AFR-00222L	Consult Molex	Universal Splice Tray Mounting Bracket	55
35-X002	Consult Molex	Label holder and label pack (100) for Euromod/MOD-SNAP C5e	88	AFR-00229	180600100	6 Fibre Shuttered SC/APC Adapter Plate, Singlemode	60
35-X003	Consult Molex	Label holder and label pack (250) for Euromod Wallplate	88	AFR-00311	180600078	6 Fibre Shuttered Duplex SC Adapter Plate, Multimode OM3	60
35-X004	Consult Molex	Label holder and label pack (100) for C5e Fixed Wallplates	88	AFR-00334	180690050	5 Fibre Mechanical Splice Holder	57
39.A0360	181770242	PowerCat 5e U/UTP, PVC Cable, Eca - Grey - 305m	35	AFR-00335	180690051	6 Fibre Fusion Splice Holder	57
39-504-5e	18170009	PowerCat 5e U/UTP LS0H Cable Dca-s2,d2,a1 Violet - 305m	35	AFR-00337	180690053	12 Fibre Fusion Splice Holder	58
39A-504-FT	Consult Molex	PowerCat 5e F/UTP PVC Cable Eca- Yellow - 305m	40	AFR-00337	180690053	12 Fibre Fusion Splice Holder	57
39A-504-LS	Consult Molex	PowerCat 5e F/UTP LS0H Cable Dca-s2,d2,a1 Violet 305m	40	AFR-00340	183190000	Modular Splice Cassette 6 Fibre Singlemode OS1 Duplex SC	58
42.1B.011.A003*	182080061	PowerCat 5e MOD-SNAP RJLP Module RJ45 568B UTP - White	38	AFR-00341	183190001	Modular Splice Cassette 6 Fibre Multimode OM1 Duplex SC	58
42-311-02	181400006	Single Gang MOD-SNAP 1 Aperture - 86 x 86mm	87	AFR-00342	183190002	Modular Splice Cassette 6 Fibre Multimode OM2 Duplex SC	58
42-311-02	181400006	MOD-SNAP Single Gang, Single Aperture, 86mm x 86mm - Unloaded	89	AFR-00343	183190003	Modular Splice Cassette 6 Fibre Multimode OM3 Duplex SC	58
42-312-02	181400005	Single Gang MOD-SNAP 2 Aperture - 86 x 86mm	87	AFR-00344	183190004	Modular Splice Cassette 12 Fibre Singlemode OS1 Duplex SC	58
42-312-02	181400005	MOD-SNAP Single Gang, Double Aperture, 86mm x 86mm - Unloaded	89	AFR-00345	183190005	Modular Splice Cassette 12 Fibre Multimode OM1 Duplex SC	58
42-314-02	181400008	Double Gang MOD-SNAP 4 Aperture - 86 x 146mm	87	AFR-00346	Consult Molex	Modular Splice Cassette 12 Fibre Multimode OM2 Duplex SC	58
42-314-02	181400008	MOD-SNAP Double Gang, 4 Aperture, 86mm x 146mm - Unloaded	89	AFR-00347	183190007	Modular Splice Cassette 12 Fibre Multimode OM3 Duplex SC	58
91.10.332.00100	180610082	ST Pigtail, OM3 LS0H - 1m	50	AFR-00348	183190008	Modular Splice Cassette 12 Fibre Singlemode OS1 Duplex LC	58
91.10.432.00100	Consult Molex	ST Pigtail, OM4 LS0H - 1m	50	AFR-00349	183190009	Modular Splice Cassette 12 Fibre Multimode OM1 Duplex LC	58
91.10.532.00100	180610081	ST Pigtail, OM2 LS0H - 1m	50	AFR-00350	183190010	Modular Splice Cassette 12 Fibre Multimode OM2 Duplex LC	58
91.10.832.00100	180610080	ST Pigtail, OS2 LS0H - 1m	50	AFR-00351	183190011	Modular Splice Cassette 12 Fibre Multimode OM3 Duplex LC	58
91.30.332.00100	180610093	SC Pigtail, OM3 LS0H - 1m	50	AFR-00352	183190012	Modular Splice Cassette 24 Fibre Singlemode OS1 Quad LC	58
91.30.432.00100	Consult Molex	SC Pigtail, OM4 LS0H - 1m	50	AFR-00353	183190013	Modular Splice Cassette 24 Fibre Multimode OM1 Quad LC	58
91.30.532.00100	180610091	SC Pigtail, OM2 LS0H - 1m	50	AFR-00354	183190014	Modular Splice Cassette 24 Fibre Multimode OM2 Quad LC	58
91.30.832.00100	180610095	SC Pigtail, OS2 LS0H - 1m	50	AFR-00355	183190015	Modular Splice Cassette 24 Fibre Multimode OM3 Quad LC	58
91.3M.372.YYYL0	Consult Molex	Optical Fibre Patch Cords, LC Uniboot-LC Uniboot, Multimode OM3, Low Loss, LS0H - Aqua	50	AFR-00357	180600135	ST 6 Fibre SM Adapter Plate	60
91.A0860	Consult Molex	Gland 4-8mm M20	53	AFR-00358	180600136	SC Duplex 6 Fibre SM Adapter Plate - Blue	60
91.A0870	Consult Molex	Gland 7.5-10mm M20	53	AFR-00360	180600138	SC Duplex 6 Fibre MM Adapter Plate - Beige	60
91.A0880	Consult Molex	Gland 9.5-13.2mm M20	53	AFR-00362	180600140	SC Duplex 12 Fibre Adapter Plate, Multimode - Beige	61
91.A0890	Consult Molex	Gland 13-18mm M20	53	AFR-00363	180600141	6 Fibre Blank Plastic pack of 4	60
91.L0.332.00100	180610094	LC Pigtail, OM3 LS0H - 1m	50	AFR-00364	180600142	ST 6 Fibre Adapter Plate unloaded	60
91.L0.432.00100	Consult Molex	LC Pigtail, OM4 LS0H - 1m	50	AFR-00365	180600143	LC Duplex 12 Fibre SM Adapter Plate - Blue	61
91.L0.532.00100	180610092	LC Pigtail, OM2 LS0H - 1m	50	AFR-00366	180600144	LC Duplex 12 Fibre MM Adapter Plate - Beige	61
91.L0.832.00100	180610096	LC Pigtail, OS2 LS0H - 1m	50	AFR-00368	180600146	SC Duplex 12 Fibre Adapter Plate, Singlemode - Blue	61
91.MM.372.YYYL0	Consult Molex	Optical Fibre Patch Cords, LC Uniboot-LC Uniboot, Multimode OM3, Low Loss, LS0H - Aqua	50	AFR-00369	180600147	LC Quad 12 Fibre SM Adapter Plate - Blue	61
91.MM.472.YYYL0	Consult Molex	Optical Fibre Patch Cords, LC Uniboot-LC Uniboot, Multimode OM4, Low Loss, LS0H - Erica Violet	50	AFR-00370	180600148	LC Quad 12 Fibre MM Adapter Plate - Beige	61
91.MM.872.YYYL0	Consult Molex	Optical Fibre Patch Cords, LC Uniboot-LC Uniboot, Singlemode OS1/2, Low Loss, LS0H - Yellow	50	AFR-00371	180600149	ST 6 Fibre MM Adapter Plate	60
91.XX.XXX.XXXX.X	Consult Molex	Fibre Optic Patch Cords	49	AFR-00372	180600150	SC Duplex 6 Fibre MM OM3 Adapter Plate - Aqua	60
91HAAABCDEFHGIJ	Consult Molex	Hybrid Pre-Terminated Cable Assemblies	74	AFR-00374	180600152	SC Duplex 12 Fibre Adapter Plate, Multimode OM3 - Aqua	61
91-MXXXAC-DEF-GGGH	Consult Molex	MTP-MTP Pre-Terminated Multicore Cable Assemblies	75	AFR-00375	180600153	LC Quad 12 Fibre MM OM3 Adapter Plate - Aqua	61
91-XAABB-YLLLC-E*	Consult Molex	Pre-Terminated Solutions ModLinkTM Fibre Plug & Play	73	AFR-00375-EV	180600306	LC Quad 12 Fibre MM OM4 Adapter Plate - Erica Violet	61
91XXXXXXXXXXXXXXXX	Consult Molex	Pre-terminated Fibre Optic Leads	48	AFR-00376	Consult Molex	LC Duplex 12 Fibre MM OM3 Adapter Plate - Aqua	61
♦AFR-00001	180600027	Universal Splicing Tray	57	AFR-00376-EV	180600305	LC Duplex 12 Fibre Adapter Plate, Multimode - Erica Violet	61
♦AFR-00336	180690052	Universal Splice Tray - 24 Fibres	57				
♦AFR-00338	180690054	Universal Splice Tray - Unloaded	57				
AFR-00114	182080069	6 Fibre Shuttered Duplex ST-SC Adapter Plate, Singlemode	60				
AFR-00116	180600040	6 Fibre Shuttered Duplex ST-SC Adapter Plate, Multimode	60				

Order No. Reference

Order No.	SAP No.	Description	Page	Order No.	SAP No.	Description	Page
AFR-00377	180600155	LC Quad 24 Fibre MM OM1 Adapter Plate - Beige	61	AFR-00600-0L	180600402	SC Simplex, 24 Fibre Adapter Plate, Unshuttered, MM - Beige	51
AFR-00378	180600156	LC Quad 24 Fibre MM OM3 Adapter Plate - Aqua	61	AFR-00601-AQ	180600403	SC Simplex, 24 Fibre Adapter Plate, Unshuttered, MM - Aqua	51
AFR-00379	180600157	LC Quad 24 Fibre SM OS1 Adapter Plate - Blue	61	AFR-00602-EV	180600404	SC Simplex, 24 Fibre Adapter Plate, Unshuttered, MM - Erica Violet	51
AFR-00380	183190016	Modular Splice Cassette Housing and Lid	58	AFR-00603-BL	180600405	LC Duplex, 48 Fibre Adapter Plate, Unshuttered, SM - Blue	51
AFR-00382	183190017	Modular Splice Cassette 6 Fibre Singlemode OS1 ST	58	AFR-00604-GR	180600406	LC/APC Duplex, 48 Fibre Adapter Plate, Unshuttered, SM - Green	51
AFR-00383	183190018	Modular Splice Cassette 6 Fibre Multimode OM1 ST	58	AFR-00605-0L	180600407	LC Duplex, 48 Fibre Adapter Plate, Unshuttered, MM - Beige	51
AFR-00384	183190019	Modular Splice Cassette 6 Fibre Multimode OM2 ST	58	AFR-00606-AQ	180600408	LC Duplex, 48 Fibre Adapter Plate, Unshuttered, MM - Aqua	51
AFR-00387	182620013	LC Multimode OM1 250/900µm Beige 10 x Connector Kit	64	AFR-00607-EV	180600409	LC Duplex, 48 Fibre Adapter Plate, Unshuttered, MM - Erica Violet	51
AFR-00388	182620014	LC Multimode OM2 250/900µm Black 10 x Connector Kit	64	AFR-00608-BL	180600410	SC Simplex, 48 Fibre Adapter Plate, Unshuttered, SM - Blue	51
AFR-00389	182620015	LC Multimode OM3 10g 250/900µm Aqua 10 x Connector Kit	64	AFR-00609-GR	180600411	SC/APC Simplex, 48 Fibre Adapter Plate, Unshuttered, SM - Green	51
AFR-00390	182620016	LC Singlemode OS1 250/900µm Blue 10 x Connector Kit	64	AFR-00610-0L	180600412	SC Simplex, 48 Fibre Adapter Plate, Unshuttered, MM - Beige	51
AFR-00391	182620017	SC Multimode OM1 250/900µm Beige 10 x Connector Kit	64	AFR-00611-AQ	180600413	SC Simplex, 48 Fibre Adapter Plate, Unshuttered, MM - Aqua	51
AFR-00392	182620018	SC Multimode OM2 250/900µm Black 10 x Connector Kit	64	AFR-00612-EV	180600414	SC Simplex, 48 Fibre Adapter Plate, Unshuttered, MM - Erica Violet	51
AFR-00393	182620019	SC Multimode OM3 10g 250/900µm Aqua 10 x Connector Kit	64	AFR-00613-BL	180600415	LC Quad, 96 Fibre Adapter Plate, Unshuttered, SM - Blue	51
AFR-00394	182620020	SC Singlemode OS1 250/900µm Blue 10 x Connector Kit	64	AFR-00614-GR	180600416	LC/APC Quad, 96 Fibre Adapter Plate, Unshuttered, SM - Green	51
AFR-00395	182620021	SC/APC Singlemode OS1 250/900µm APC Green 10 x Connector Kit	64	AFR-00615-0L	180600417	LC Quad, 96 Fibre Adapter Plate, Unshuttered, MM - Beige	51
AFR-00440	183190030	Adapter Plate 3 x PowerCat DataGate unloaded	28	AFR-00616-AQ	180600418	LC Quad, 96 Fibre Adapter Plate, Unshuttered, MM - Aqua	51
AFR-00441	183190030	Adapter Plate 3x PowerCat 6A DataGate (with grounding screws) unloaded	17	AFR-00617-EV	180600419	LC Quad, 96 Fibre Adapter Plate, Unshuttered, MM - Erica Violet	51
AFR-00464-04	180600430	FC Simplex 24 Fibre Adapter Plate, SM	52	AFR-00618-BL	180600420	SC Duplex, 24 Fibre Adapter Plate, Unshuttered, SM - Blue	51
AFR-00465-04	180600431	FC Simplex 24 Fibre Adapter Plate, MM	52	AFR-00619-GR	180600421	SC/APC Duplex, 24 Fibre Adapter Plate, Unshuttered, SM - Green	51
AFR-00467-04	180600432	ST Simplex 24 Fibre Adapter Plate, SM/MM	52	AFR-00620-0L	180600422	SC Duplex, 24 Fibre Adapter Plate, Unshuttered, MM - Beige	51
AFR-00468-04	180600394	6 Pak Adapter Front Plate	51	AFR-00621-AQ	180600423	SC Duplex, 24 Fibre Adapter Plate, Unshuttered, MM - Aqua	51
AFR-00469-04	180600395	Full Length Blanking Plate	51	AFR-00622-EV	180600424	SC Duplex, 24 Fibre Adapter Plate, Unshuttered, MM - Erica Violet	51
AFR-00470	180600217	Universal Splice Tray, 24 Fibre with built in Cable Management, 1U Global Enclosure (Self Adhesive, 2 PC)	53	AFR-00623-BL	180600425	LC Quad, 48 Fibre Adapter Plate, Unshuttered, SM - Blue	51
AFR-00470	180600217	Universal Splice Tray, 24 Fibre with built in Cable Management for 1U Multi-Function Fibre Enclosure (Self Adhesive, 2 pcs)	57	AFR-00624-GR	180600426	LC/APC Quad, 48 Fibre Adapter Plate, Unshuttered, SM - Green	52
AFR-00472	180600219	Self Adhesive Cable Management Hub (3 PC)	53	AFR-00625-0L	180600427	LC Quad, 48 Fibre Adapter Plate, Unshuttered, MM - Beige	52
AFR-00472	180600219	Self Adhesive Cable Management Hub (3 pcs)	57	AFR-00626-AQ	180600428	LC Quad, 48 Fibre Adapter Plate, Unshuttered, MM - Aqua	52
AFR-00486	183190034	Modular Splice Cassette 6 Fibre OM4 Duplex SC - Erica Violet	58	AFR-00627-EV	180600429	LC Quad, 48 Fibre Adapter Plate, Unshuttered, MM - Erica Violet	52
AFR-00486L	183190035	Modular Splice Cassette 6 Fibre OM4 Duplex SC Low Loss - Erica Violet	58	AFR-00628-BL	180600433	SC Duplex, 36 Fibre Adapter Plate, Unshuttered, SM - Blue	52
AFR-00487	183190039	Modular Splice Cassette 12 Fibre OM4 Duplex SC - Erica Violet	58	AFR-00629-GR	180600434	SC/APC Duplex, 36 Fibre Adapter Plate, Unshuttered, SM - Green	52
AFR-00487L	183190040	Modular Splice Cassette 12 Fibre OM4 Duplex SC Low Loss - Erica Violet	58	AFR-00630-0L	180600435	SC Duplex, 36 Fibre Adapter Plate, Unshuttered, MM - Beige	52
AFR-00488	183190044	Modular Splice Cassette 12 Fibre OM4 Duplex LC - Erica Violet	58	AFR-00631-AQ	180600436	SC Duplex, 36 Fibre Adapter Plate, Unshuttered, MM - Aqua	52
AFR-00488L	183190045	Modular Splice Cassette 12 Fibre OM4 Duplex LC Low Loss- Erica Violet	58	AFR-00632-EV	180600437	SC Duplex, 36 Fibre Adapter Plate, Unshuttered, MM - Erica Violet	52
AFR-00489	183190049	Modular Splice Cassette 24 Fibre OM4 Quad LC - Erica Violet	58	AFR-00633-BL	180600438	SC Simplex, 6 Fibre Adapter Plate, Unshuttered, SM - Blue	52
AFR-00489L	183190050	Modular Splice Cassette 24 Fibre OM4 Quad LC Low Loss - Erica Violet	58	AFR-00634-GR	180600439	SC/APC Simplex, 6 Fibre Adapter Plate, Unshuttered, SM - Green	52
AFR-00500	1890600246	SC Duplex 6 Fibre MM OM4 Adapter Plate - Erica Violet	60	AFR-00635-0L	180600440	SC Simplex, 6 Fibre Adapter Plate, Unshuttered, MM - Beige	52
AFR-00501	180600247	SC Duplex 12 Fibre Adapter Plate, Multimode OM4 - Erica Violet	61	AFR-00636-AQ	180600441	SC Simplex, 6 Fibre Adapter Plate, Unshuttered, MM - Aqua	52
AFR-00502	180600248	LC Quad 24 Fibre MM OM4 Adapter Plate - Erica Violet	61	AFR-00637-EV	180600442	SC Simplex, 6 Fibre Adapter Plate, Unshuttered, MM - Erica Violet	52
AFR-00503	183190070	Modular Splice Cassette 6 Fibre OM4 Duplex SC - Aqua	58	AFR-00638-BL	180600443	LC Duplex, 12 Fibre Adapter Plate, Unshuttered, SM - Blue	52
AFR-00503L	183190071	Modular Splice Cassette 6 Fibre OM4 Duplex SC Low Loss - Aqua	58	AFR-00639-GR	180600444	LC/APC Duplex, 12 Fibre Adapter Plate, Unshuttered, SM - Green	52
AFR-00504	183190072	Modular Splice Cassette 12 Fibre OM4 Duplex SC - Aqua	58	AFR-00640-0L	180600445	LC Duplex, 12 Fibre Adapter Plate, Unshuttered, MM - Beige	52
AFR-00504L	183190073	Modular Splice Cassette 12 Fibre OM4 Duplex SC Low Loss - Aqua	58	AFR-00641-AQ	180600446	LC Duplex, 12 Fibre Adapter Plate, Unshuttered, MM - Aqua	52
AFR-00505	183190074	Modular Splice Cassette 12 Fibre OM4 Duplex LC - Aqua	58	AFR-00642-EV	180600447	LC Duplex, 12 Fibre Adapter Plate, Unshuttered, MM - Erica Violet	52
AFR-00505L	183190075	Modular Splice Cassette 12 Fibre OM4 Duplex LC Low Loss - Aqua	58	AFR-00643-BL	180600448	SC Duplex, 12 Fibre Adapter Plate, Unshuttered, SM - Blue	52
AFR-00506	183190076	Modular Splice Cassette 24 Fibre OM4 Quad LC - Aqua	58	AFR-00644-GR	180600449	SC/APC Duplex, 12 Fibre Adapter Plate, Unshuttered, SM - Green	52
AFR-00506L	183190077	Modular Splice Cassette 24 Fibre OM4 Quad LC Low Loss - Aqua	58				
AFR-00548-EV	180600310	6 Fibre Angled Duplex SC Adapter Plate, OM3 - Aqua	60				
AFR-00598-BL	180600392	SC Simplex, 24 Fibre Adapter Plate, Unshuttered, SM - Blue	51				
AFR-00599-GR	180600393	SC/APC Simplex, 24 Fibre Adapter Plate, Unshuttered, SM - Green	51				

Order No. Reference

Order No.	SAP No.	Description	Page	Order No.	SAP No.	Description	Page
AFR-00645-OL	180600450	SC Duplex, 12 Fibre Adapter Plate, Unshuttered, MM - Beige	52	CAA-00358	183530002	Category 7 S/FTP LS0H Cable Dca-s1a,d1,a1 Violet - 1000m	16
AFR-00646-AQ	180600451	SC Duplex, 12 Fibre Adapter Plate, Unshuttered, MM - Aqua	52	CAA-00360	183530002	Category 7A S/FTP LS0H Cable Dca-s1a,d1,a1 Violet - 500m reel	16
AFR-00647-EV	180600452	SC Duplex, 12 Fibre Adapter Plate, Unshuttered, MM - Erica Violet	52	CAA-00380	Consult Molex	Category 3 25 Pair LS0H Eca cable - per metre	86
AFR-00648-BL	180600453	LC Quad, 24 Fibre Adapter Plate, Unshuttered, SM - Blue	52	CAA-00382	Consult Molex	Category 3 50 Pair LS0H Eca cable - per metre	86
AFR-00649-GR	180600454	LC/APC Quad, 24 Fibre Adapter Plate, Unshuttered, SM - Green	52	CAA-00418	183020048	Cat6A U/FTP Gel Filled Outdoor PE Cable Nylon Fca Blue 305m	20
AFR-00650-OL	180600455	LC Quad, 24 Fibre Adapter Plate, Unshuttered, MM - Beige	52	CAA-00419-OH	181740138	Cat6 U/UTP Gel Filled Outdoor PE Cable Nylon Fca Blue 305 m	25
AFR-00651-AQ	180600456	LC Quad, 24 Fibre Adapter Plate, Unshuttered, MM - Aqua	52	CAA-00424-BL	1810000014	PowerCat 6A Unshielded Eca Cable Blue 500m reel	14
AFR-00652-EV	180600457	LC Quad, 24 Fibre Adapter Plate, Unshuttered, MM - Erica Violet	52	CAA-0322L-VL	183020029	PowerCat 6A U/FTP LS0H Cable Dca-s2,d1,a1 Violet - 500m	16
AFR-00728-BL	180600496	SC Simplex, 6 Fibre Adapter Plate, Shuttered, SM - Blue	52	CAA-0334-VL	183020023	PowerCat 6A U/FTP LS0H Cable Cca-s1a,d1,a1 Violet - 500m	16
AFR-00729-GR	180600497	SC/APC Simplex, 6 Fibre Adapter Plate, Shuttered, SM - Green	52	CAA-0336-VL	Consult Molex	PowerCat 6 LS0H Cable B2ca-s1a,d1,a1 - 305m Reel in a Box	25
AFR-00730-OL	180600498	SC Simplex, 6 Fibre Adapter Plate, Shuttered, MM - Beige	52	CAA-0413-VL	183020040	PowerCat 6A U/FTP LS0H Cable B2ca-s1a,d1,a1 Violet 500m	16
AFR-00731-AQ	180600499	SC Simplex, 6 Fibre Adapter Plate, Shuttered, MM - Aqua	52	CFR-00373	180580441	4 Core Internal/External Tight buffered OM2 Cable - Green Eca	44
AFR-00732-EV	180600500	SC Simplex, 6 Fibre Adapter Plate, Shuttered, MM - Erica Violet	52	CFR-00374	180580441	6 Core Internal/External Tight buffered OM2 Cable - Green Eca	44
AFR-00733-BL	180600501	LC Duplex, 12 Fibre Adapter Plate, Shuttered, SM - Blue	52	CFR-00375	180580441	8 Core Internal/External Tight buffered OM2 Cable - Green Eca	44
AFR-00734-GR	180600502	LC/APC Duplex, 12 Fibre Adapter Plate, Shuttered, SM - Green	52	CFR-00376	180580441	12 Core Internal/External Tight buffered OM2 Cable - Green Eca	44
AFR-00735-OL	180600503	LC Duplex, 12 Fibre Adapter Plate, Shuttered, MM - Beige	52	CFR-00378	180580445	24 Core Internal/External Tight buffered OM2 Cable - Green Eca	44
AFR-00736-AQ	180600504	LC Duplex, 12 Fibre Adapter Plate, Shuttered, MM - Aqua	52	CFR-00380	180580449	4 Core Internal/External Tight buffered OM3 Cable - Green Eca	44
AFR-00737-EV	180600505	LC Duplex, 12 Fibre Adapter Plate, Shuttered, MM - Erica Violet	52	CFR-00381	180580451	6 Core Internal/External Tight buffered OM3 Cable - Green Eca	44
AFR-00738-BL	180600506	SC Duplex, 12 Fibre Adapter Plate, Shuttered, SM - Blue	52	CFR-00382	180580453	8 Core Internal/External Tight buffered OM3 Cable - Green Eca	44
AFR-00739-GR	180600507	SC/APC Duplex, 12 Fibre Adapter Plate, Shuttered, SM - Green	52	CFR-00383	180580454	12 Core Internal/External Tight buffered OM3 Cable - Green Eca	44
AFR-00740-OL	180600508	SC Duplex, 12 Fibre Adapter Plate, Shuttered, MM - Beige	52	CFR-00384	180580455	24 Core Internal/External Tight buffered OM3 Cable - Green Eca	44
AFR-00741-AQ	180600509	SC Duplex, 12 Fibre Adapter Plate, Shuttered, MM - Aqua	52	CFR-00387	180580464	4 Core Internal/External Tight buffered OS2 Cable - Green Eca	45
AFR-00742-EV	180600510	SC Duplex, 12 Fibre Adapter Plate, Shuttered, MM - Erica Violet	52	CFR-00388	180580466	6 Core Internal/External Tight buffered OS2 Cable - Green Eca	45
AFR-00743-BL	180600511	LC Duplex, 24 Fibre Adapter Plate, Shuttered, SM - Blue	52	CFR-00389	180580468	8 Core Internal/External Tight buffered OS2 Cable - Green Eca	45
AFR-00744-GR	180600512	LC/APC Duplex, 24 Fibre Adapter Plate, Shuttered, SM - Green	52	CFR-00390	180580469	12 Core Internal/External Tight buffered OS2 Cable - Green Eca	45
AFR-00745-OL	180600513	LC Duplex, 24 Fibre Adapter Plate, Shuttered, MM - Beige	52	CFR-00392	180580471	24 Core Internal/External Tight buffered OS2 Cable - Green Eca	45
AFR-00746-AQ	180600514	LC Duplex, 24 Fibre Adapter Plate, Shuttered, MM - Aqua	52	CFR-00493	180580677	4 Core Internal/External Tight buffered OM3 Cable - Aqua Cca-s1a,d1,a1	44
AFR-00747-EV	180600515	LC Duplex, 24 Fibre Adapter Plate, Shuttered, MM - Erica Violet	52	CFR-00494	180580678	6 Core Internal/External Tight buffered OM3 Cable - Aqua Cca-s1a,d1,a1	44
AFR-00748-BL	180600516	SC Duplex, 24 Fibre Adapter Plate, Shuttered, SM - Blue	52	CFR-00495	180580679	8 Core Internal/External Tight buffered OM3 Cable - Aqua Cca-s1a,d1,a1	44
AFR-00749-GR	180600517	SC/APC Duplex, 24 Fibre Adapter Plate, Shuttered, SM - Green	52	CFR-00496	180580523	12 Core Internal/External Tight buffered OM3 Cable - Aqua Cca-s1a,d1,a1	44
AFR-00750-OL	180600518	SC Duplex, 24 Fibre Adapter Plate, Shuttered, MM - Beige	52	CFR-00497	180580640	24 Core Internal/External Tight buffered OM3 Cable - Aqua Cca-s1a,d1,a1	44
AFR-00751-AQ	180600519	SC Duplex, 24 Fibre Adapter Plate, Shuttered, MM - Aqua	52	CFR-00498	180580680	4 Core Internal/External Tight buffered OS2 Cable - Yellow Cca-s1a,d1,a1	45
AFR-00752-EV	180600520	SC Duplex, 24 Fibre Adapter Plate, Shuttered, MM - Erica Violet	52	CFR-00499	180580678	6 Core Internal/External Tight buffered OS2 Cable - Yellow Cca-s1a,d1,a1	45
AFR-00753-BL	180600521	LC Quad, 48 Fibre Adapter Plate, Shuttered, SM - Blue	52	CFR-00500	180580682	8 Core Internal/External Tight buffered OS2 Cable - Yellow Cca-s1a,d1,a1	45
AFR-00754-GR	180600522	LC/APC Quad, 48 Fibre Adapter Plate, Shuttered, SM - Green	52	CFR-00501	180580285	12 Core Internal/External Tight buffered OS2 Cable - Yellow Cca-s1a,d1,a1	45
AFR-00755-OL	180600523	LC Quad, 48 Fibre Adapter Plate, Shuttered, MM - Beige	52	CFR-00502	180580683	24 Core Internal/External Tight buffered OS2 Cable - Yellow Cca-s1a,d1,a1	45
AFR-00756-AQ	180600524	LC Quad, 48 Fibre Adapter Plate, Shuttered, MM - Aqua	52	CFR-00544	Consult Molex	4 Core Loose Tube Armoured OM2 Fibre Cable	47
AFR-00757-EV	180600525	LC Quad, 48 Fibre Adapter Plate, Shuttered, MM - Erica Violet	52	CFR-00545	Consult Molex	6 Core Loose Tube Armoured OM2 Fibre Cable	47
CAA-00161	181750036	PowerCat 6 F/UTP PVC Cable Eca Grey - 500m	32	CFR-00546	Consult Molex	8 Core Loose Tube Armoured OM2 Fibre Cable	47
CAA-00251	181750035	PowerCat 6 F/FTP LS0H Cable Dca-s2,d2,a1 Violet - 500m	32	CFR-00547	Consult Molex	12 Core Loose Tube Armoured OM2 Fibre Cable	47
CAA-00302	181740038	PowerCat 6 U/UTP PVC Cable Eca Grey - 305m reel in a box	25	CFR-00548	Consult Molex	16 Core Loose Tube Armoured OM2 Fibre Cable	47
CAA-00305	181740056	PowerCat 6 U/UTP LS0H Cable Dca-s2,d2,a1 Violet - 305m reel in a box	25	CFR-00549	Consult Molex	24 Core Loose Tube Armoured OM2 Fibre Cable	47
CAA-00325	181740057	PowerCat 6 U/UTP LS0H Cable Dca-s2,d2,a1 Violet - 500m	25	CFR-00551	Consult Molex	4 Core Loose Tube Armoured OM3 Fibre Cable	47
CAA-00326	181740058	PowerCat 6 U/UTP PVC Cable Eca Grey - 500m Reel	25	CFR-00552	Consult Molex	6 Core Loose Tube Armoured OM3 Fibre Cable	47
CAA-00344	Consult Molex	Category 3 50 Pair LS0H Eca cable - 2km reel	86	CFR-00553	Consult Molex	8 Core Loose Tube Armoured OM3 Fibre Cable	47
CAA-00346	Consult Molex	Category 3 100 Pair LS0H Eca cable - 2km reel	86	CFR-00554	Consult Molex	12 Core Loose Tube Armoured OM3 Fibre Cable	47
				CFR-00555	Consult Molex	16 Core Loose Tube Armoured OM3 Fibre Cable	47
				CFR-00556	Consult Molex	24 Core Loose Tube Armoured OM3 Fibre Cable	47
				CFR-00558	Consult Molex	4 Core Loose Tube Armoured OS1/S2 Fibre Cable	47
				CFR-00559	Consult Molex	6 Core Loose Tube Armoured OS1/S2 Fibre Cable	47
				CFR-00560	Consult Molex	8 Core Loose Tube Armoured OS1/S2 Fibre Cable	47
				CFR-00561	Consult Molex	12 Core Loose Tube Armoured OS1/S2 Fibre Cable	47
				CFR-00562	Consult Molex	16 Core Loose Tube Armoured OS1/S2 Fibre Cable	47

Order No. Reference

Order No.	SAP No.	Description	Page	Order No.	SAP No.	Description	Page
CFR-00563	Consult Molex	24 Core Loose Tube Armoured OS1/S2 Fibre Cable	47	CFR-00671	183150054	24 Core Multipurpose Loose Tube OS2 Cable - Yellow Dca-s2-d2,a1	46
CFR-00569	180580481	4 Core Multipurpose Loose Tube OM2 Cable - Blue Eca	45	CFR-00672	183150055	4 Core Multipurpose Loose Tube OM3 Cable - Aqua Bca-s1a,d1,a1	45
CFR-00570	180580482	6 Core Multipurpose Loose Tube OM2 Cable - Blue Eca	45	CFR-00673	183150056	6 Core Multipurpose Loose Tube OM3 Cable - Aqua Bca-s1a,d1,a1	45
CFR-00571	180580483	8 Core Multipurpose Loose Tube OM2 Cable - Blue Eca	45	CFR-00674	183150057	8 Core Multipurpose Loose Tube OM3 Cable - Aqua Bca-s1a,d1,a1	45
CFR-00572	180580484	12 Core Multipurpose Loose Tube OM2 Cable - Blue Eca	45	CFR-00675	183150058	12 Core Multipurpose Loose Tube OM3 Cable - Aqua Bca-s1a,d1,a1	45
CFR-00573	180580485	24 Core Multipurpose Loose Tube OM2 Cable - Blue Eca	45	CFR-00676	183150059	24 Core Multipurpose Loose Tube OM3 Cable - Aqua Bca-s1a,d1,a1	45
CFR-00574	180580486	4 Core Multipurpose Loose Tube OM3 Cable - Blue Eca	46	CFR-00677	183150060	4 Core Multipurpose Loose Tube OM4 Cable - Erika Violet Bca-s1a,d1,a1	46
CFR-00575	180580487	6 Core Multipurpose Loose Tube OM3 Cable - Blue Eca	46	CFR-00678	183150061	6 Core Multipurpose Loose Tube OM4 Cable - Erika Violet Bca-s1a,d1,a1	46
CFR-00576	180580488	8 Core Multipurpose Loose Tube OM3 Cable - Blue Eca	46	CFR-00679	183150062	8 Core Multipurpose Loose Tube OM4 Cable - Erika Violet Bca-s1a,d1,a1	46
CFR-00577	180580489	12 Core Multipurpose Loose Tube OM3 Cable - Blue Eca	46	CFR-00680	183150063	12 Core Multipurpose Loose Tube OM4 Cable - Erika Violet Bca-s1a,d1,a1	46
CFR-00578	180580491	24 Core Multipurpose Loose Tube OM3 Cable - Blue Eca	46	CFR-00681	183150064	24 Core Multipurpose Loose Tube OM4 Cable - Erika Violet Bca-s1a,d1,a1	46
CFR-00579	180580497	4 Core Multipurpose Loose Tube OS2 Cable - Blue Eca	46	CFR-00682	183150065	4 Core Multipurpose Loose Tube OS2 Cable - Yellow Bca-s1a,d1,a1	46
CFR-00580	180580498	6 Core Multipurpose Loose Tube OS2 Cable - Blue Eca	46	CFR-00683	183150066	6 Core Multipurpose Loose Tube OS2 Cable - Yellow Bca-s1a,d1,a1	46
CFR-00581	180580499	8 Core Multipurpose Loose Tube OS2 Cable - Blue Eca	46	CFR-00684	183150067	8 Core Multipurpose Loose Tube OS2 Cable - Yellow Bca-s1a,d1,a1	46
CFR-00582	180580500	12 Core Multipurpose Loose Tube OS2 Cable - Blue Eca	46	CFR-00685	183150068	12 Core Multipurpose Loose Tube OS2 Cable - Yellow Bca-s1a,d1,a1	46
CFR-00583	180580501	24 Core Multipurpose Loose Tube OS2 Cable - Blue Eca	46	CFR-00686	183150069	24 Core Multipurpose Loose Tube OS2 Cable - Yellow Bca-s1a,d1,a1	46
CFR-00584	180580370	4 Core Internal/External Tight buffered OM4 Cable - Green Eca	44	CFR-00687	183280004	4 Core Internal/External Tight buffered OM3 Cable - Aqua Bca-s1a,d1,a1	44
CFR-00585	180580371	6 Core Internal/External Tight buffered OM4 Cable - Green Eca	44	CFR-00688	183280005	6 Core Internal/External Tight buffered OM3 Cable - Aqua Bca-s1a,d1,a1	44
CFR-00586	180580372	8 Core Internal/External Tight buffered OM4 Cable - Green Eca	44	CFR-00689	183280006	8 Core Internal/External Tight buffered OM3 Cable - Aqua Bca-s1a,d1,a1	44
CFR-00587	180580373	12 Core Internal/External Tight buffered OM4 Cable - Green Eca	44	CFR-00690	183280007	12 Core Internal/External Tight buffered OM3 Cable - Aqua Bca-s1a,d1,a1	44
CFR-00589	180580375	24 Core Internal/External Tight buffered OM4 Cable - Green Eca	44	CFR-00691	183280008	24 Core Internal/External Tight buffered OM3 Cable - Aqua Bca-s1a,d1,a1	44
CFR-00594	180580492	4 Core Multipurpose Loose Tube OM4 Cable - Blue Eca	46	CFR-00692	183280009	4 Core Internal/External Tight buffered OM4 Cable - Erika Violet Bca-s1a,d1,a1	44
CFR-00595	180580493	6 Core Multipurpose Loose Tube OM4 Cable - Blue Eca	46	CFR-00693	183280010	6 Core Internal/External Tight buffered OM4 Cable - Erika Violet Bca-s1a,d1,a1	44
CFR-00596	180580494	8 Core Multipurpose Loose Tube OM4 Cable - Blue Eca	46	CFR-00694	183280011	8 Core Internal/External Tight buffered OM4 Cable - Erika Violet Bca-s1a,d1,a1	44
CFR-00597	180580495	12 Core Multipurpose Loose Tube OM4 Cable - Blue Eca	46	CFR-00695	183280012	12 Core Internal/External Tight buffered OM4 Cable - Erika Violet Bca-s1a,d1,a1	44
CFR-00598	180580496	24 Core Multipurpose Loose Tube OM4 Cable - Blue Eca	46	CFR-00696	183280013	24 Core Internal/External Tight buffered OM4 Cable - Erika Violet Bca-s1a,d1,a1	44
CFR-00622	180580684	4 Core Internal/External Tight buffered OM4 Cable - Erika Violet Cca-s1a,d1,a1	44	CFR-00697	183280014	4 Core Internal/External Tight buffered OS2 Cable - Yellow Bca-s1a,d1,a1	45
CFR-00623	180580685	6 Core Internal/External Tight buffered OM4 Cable - Erika Violet Cca-s1a,d1,a1	44	CFR-00698	183280015	6 Core Internal/External Tight buffered OS2 Cable - Yellow Bca-s1a,d1,a1	45
CFR-00624	180580686	8 Core Internal/External Tight buffered OM4 Cable - Erika Violet Cca-s1a,d1,a1	44	CFR-00699	183280016	8 Core Internal/External Tight buffered OS2 Cable - Yellow Bca-s1a,d1,a1	45
CFR-00625	183280003	12 Core Internal/External Tight buffered OM4 Cable - Erika Violet Cca-s1a,d1,a1	44	CFR-00700	183280017	12 Core Internal/External Tight buffered OS2 Cable - Yellow Bca-s1a,d1,a1	45
CFR-00626	180580687	24 Core Internal/External Tight buffered OM4 Cable - Erika Violet Cca-s1a,d1,a1	44	CFR-00701	183280018	24 Core Internal/External Tight buffered OS2 Cable - Yellow Bca-s1a,d1,a1	45
CFR-00657	183150040	4 Core Multipurpose Loose Tube OM3 Cable - Aqua Dca-s2-d2,a1	46	CMA-00083	181050000	12" Vertical Rack Cable Manager - Front/Back & Front Door	82
CFR-00658	183150041	6 Core Multipurpose Loose Tube OM3 Cable - Aqua Dca-s2-d2,a1	46	CMA-00084	181050001	8" Vertical Rack Cable Manager - Front/Back & Front Door	82
CFR-00659	183150042	8 Core Multipurpose Loose Tube OM3 Cable - Aqua Dca-s2-d2,a1	46	CMA-00085	181050006	1U Horizontal Cable Manager	82
CFR-00660	183150043	12 Core Multipurpose Loose Tube OM3 Cable - Aqua Dca-s2-d2,a1	46	CMA-00087	181050006	2U Horizontal Cable Manager	82
CFR-00661	183150044	24 Core Multipurpose Loose Tube OM3 Cable - Aqua Dca-s2-d2,a1	46	CMA-00088	181050012	12" Vertical Cable Retainer - 5 Pack	82
CFR-00662	183150045	4 Core Multipurpose Loose Tube OM4 Cable - Erika Violet Dca-s2-d2,a1	46	CMA-00089	181050013	Spools - 2 Pack	82
CFR-00663	183150046	6 Core Multipurpose Loose Tube OM4 Cable - Erika Violet Dca-s2-d2,a1	46	CMA-00090	181050014	Finger Guides - 5 Pack	82
CFR-00664	183150047	8 Core Multipurpose Loose Tube OM4 Cable - Erika Violet Dca-s2-d2,a1	46	CMA-00091	181050015	12" Door Kit	82
CFR-00665	183150048	12 Core Multipurpose Loose Tube OM4 Cable - Erika Violet Dca-s2-d2,a1	46	CMA-00092	181050016	8" Door Kit	82
CFR-00666	183150049	24 Core Multipurpose Loose Tube OM4 Cable - Erika Violet Dca-s2-d2,a1	46	CMA-00096	181050017	8" Vertical Cable Retainer - 5 Pack	82
CFR-00667	183150050	4 Core Multipurpose Loose Tube OS2 Cable - Yellow Dca-s2-d2,a1	46	CMA-00111	181050048	Front Cable Manager	51
CFR-00668	183150051	6 Core Multipurpose Loose Tube OS2 Cable - Dca-s2-d2,a1	46	CPT-00004	180080020	Multi User Telecommunications Outlet (MUTO)	91
CFR-00669	183150052	8 Core Multipurpose Loose Tube OS2 Cable - Yellow Dca-s2-d2,a1	46	CPT-00022	180080070	6 Port PowerCat Consolidation Point Enclosure UTP 568A/B - Graphite Grey	78
CFR-00670	183150053	12 Core Multipurpose Loose Tube OS2 Cable - Yellow Dca-s2-d2,a1	46	CPT-00023	180080063	8 Port PowerCat Consolidation Point Enclosure UTP 568A/B - Graphite Grey	78
				CPT-00028	Consult Molex	12 Port Shuttered LC Consolidation Point, Singlemode	78
				CPT-00029	Consult Molex	12 Port Shuttered MT-RJ Consolidation Point, Singlemode/Multimode	78
				CPT-00030	180080066	12 Port Shuttered Duplex SC Consolidation Point, Singlemode	78
				CPT-00031	180080064	12 Port Shuttered Duplex SC Consolidation Point, Multimode	78

Order No. Reference

Order No.	SAP No.	Description	Page	Order No.	SAP No.	Description	Page
CPT-00032	180080065	PowerCat 6 6 Port Consolidation Point Enclosure RJ45 568B UTP	28	MEU-00011-02	Consult Molex	Angled Shuttered Duplex SC Module, Multimode -1 Adapter	66
CPT-00033	180080073	PowerCat 6 8 Port Consolidation Point Enclosure RJ45 568B UTP	28	MEU-00011-02	Consult Molex	Angled Shuttered Duplex SC Module, Multimode -1 Adapter	68
CPT-00034	180080059	Consolidation Point Enclosure Base - Unloaded	78	MEU-00012-02	Consult Molex	Angled Shuttered Duplex SC Module, Singlemode -1 Adapter	66
CPT-00038	180080072	Consolidation Point Enclosure Plate - 8 Port	78	MEU-00012-02	Consult Molex	Angled Shuttered Duplex SC Module, Singlemode -1 Adapter	68
CPT-00041	180080074	6 Port Consolidation Point Enclosure MT-RJ Plate, Singlemode/Multimode	78	MEU-00013-02	182620001	Angled Shuttered Duplex SC-ST Module, Multimode - 2 Adapters	66
CPT-00042	180080075	6 Port Consolidation Point Enclosure SC Plate, Singlemode	78	MEU-00013-02	182620001	Angled Shuttered Duplex SC-ST Module, Multimode - 2 Adapters	68
CPT-00043	180080076	6 Port Consolidation Point Enclosure SC Plate, Multimode	78	MEU-00014-02	182620002	Angled Shuttered Duplex SC-ST Module, Singlemode - 2 Adapters	66
CPT-00044	180080077	6 Port Consolidation Point Enclosure LC Plate, Singlemode	78	MEU-00014-02	182620002	Angled Shuttered Duplex SC-ST Module, Singlemode - 2 Adapters	68
CPT-00053	180080078	PowerCat 6A 8 Port Consolidation Point Enclosure, Shielded	18	MEU-00020-02	181900002	Euromod RJLP Module RJ45 568B FTP Category 5e - White	40
CPT-00053	180080078	PowerCat 6A 8 Port Consolidation Point Enclosure, Shielded	78	MEU-00029-02	181490006	25 x 50mm LC Module, Singlemode - 2 Adapters	66
CSP-00018-04	180400053	Punchdown Terminating Puck (Black)	94	MEU-00048-02	181210017	Angled Shuttered LC, Singlemode - 2 Adapters	66
CSP-00021.**	Consult Molex	Blank Connector Icon Labels 6-Pack (Bag of 10)	17	MEU-00048-02	181210017	Angled Shuttered LC, Singlemode - 2 Adapters	68
CSP-00021.**	Consult Molex	Blank Connector Icon Labels 6-Pack	88	MEU-00049-02	182620005	Angled Shuttered LC, Multimode - 2 Adapters	66
CSP-00022.**	Consult Molex	Data Connector Icon Labels 6-Pack	88	MEU-00049-02	182620005	Angled Shuttered LC, Multimode - 2 Adapters	68
CSP-00023.**	Consult Molex	Voice Connector Icon Labels 6-Pack	88	MEU-00056-02	181730016	PowerCat 6 Euromod II Module RJ45 568A/B UTP - White	30
CSP-00030	Consult Molex	Mounting Adapter Screw (24 pack)	53	MEU-00056-04	181730017	PowerCat 6 Euromod II Module RJ45 568A/B UTP - Black	30
CSP-00031	Consult Molex	Label holder and label pack (20) for DataGate modules	88	MEU-00058-02	181790002	PowerCat 6 Angled Euromod II RJ45 568A/B Shielded - White	33
CSP-00038	Consult Molex	Label holder and label pack (100) for Synergy Wallplates and Surface boxes	88	MEU-00058-04	181790003	PowerCat 6 Angled Euromod II RJ45 568A/B Shielded - Black	33
DCN-00001P	182030022	10 Pair Disconnect Module Clip On	86	MEU-00065-02	183010005	PowerCat 6A Angled Euromod II RJ45 Module, 568A/B - White	23
DCN-00002	182030002	10 Pair Connection Module	86	MEU-00065-04	183010012	PowerCat 6A Angled Euromod II RJ45 Module, 568A/B - Black	23
IMA-00101	183250003	MIIM 96 Channel License	11	MEU-00067-02	182620012	25 x 50mm LC Module, Multimode - 2 Adapters	66
IMA-00102	183250004	MIIM Server Application License	11	MEU-00070.**	Consult Molex	PowerCat 6A Angled Side Entry Euromod II Module, RJ45 568A/B, Shielded	23
IMD-00005	183240015	MIIM G3 Intelligent control unit for copper panel - Red	10	MEU-00071-02	181770333	Euromod Keystone Jack Fascia Wall Plate, Single Gang 86 x 86mm - white	87
IMD-00006	183240016	MIIM G3 Intelligent control unit for fibre panel - Yellow	10	MEU-00072-02	181770334	Euromod Keystone Jack Fascia Wall Plate, Double Gang 86 x 1456mm - white	87
IMM-00101	183250002	MIIM 96 Channel License Software Maintenance	11	MEU-00073-02	181770332	Euromod Keystone Jack Fascia, 25 x 50mm, unloaded - white	87
IMM-00102	183250005	MIIM Server Support/Maintenance	11	MGB-00001-02	181770082	PowerCat 6 Angled Contura Module RJ45 568A/B UTP - White	29
IMS-00100	183240000	MIIM 576 Channel Scanner	10	MGB-00002-02	181770216	Contura Module Blank - White	29
IMS-00101	183240008	MIIM 96 Channel Scanner	10	MGB-00002-02	181770216	Contura Module Blank - White	88
KFR-00008	180600025	45mm Fusion Splice Protector - 2.4mm (o.d.)	57	MGB-00002-02	181770216	Contura Blank Module - White	89
KFR-00009	180600026	61mm Fusion Splice Protector - 2.4mm (o.d.)	57	MGB-00006-02	183010004	PowerCat 6A Angled Contura RJ45 Module, 568A/B Shielded - White	18
KFR-00034	Consult Molex	Kevlar Retention Clamp (1 pc)	53	MLCDLC120M1	181810142	12 Port ModLink Cassette, Duplex LC, OM1 62.5µm Multimode	72
KFR-00038	182680003	Front Plate Label Sheet (Pack 20)	55	MLCDLC120M2	181810147	12 Port ModLink Cassette, Duplex LC, OM2 50µm Multimode	72
KFR-00039	182680004	Cable Anchor Bracket Kit (1 x cable anchor bracket, 1 x 435mm bend limiting tube)	55	MLCDLC120M3L	Consult Molex	12 Port ModLink Cassette, Duplex LC, OM3 50µm Multimode, Low Loss	72
KFR-00040	182680005	45mm Fusion Splice Protector - 2.2mm (o.d.)	55	MLCDLC120M4L	Consult Molex	12 Port ModLink Cassette, Duplex LC, OM4 50µm Multimode, Low Loss	72
KFR-00040	182680005	45mm Fusion Splice Protector - 2.2mm (o.d.)	57	MLCDLC120S2L	Consult Molex	12 Port ModLink Cassette, Duplex LC, OS1/2 Singlemode	72
KPD-00087	181980070	Category 6 110 Style Multi-Pair Termination Tool with Head and Handle	94	MLCDSC120M1	Consult Molex	12 Port ModLink Cassette, Duplex SC, OM1 62.5µm Multimode	72
KSJ-00005-0*	Consult Molex	Single Position Blank Module (Bag of 25)	17	MLCDSC120M2	Consult Molex	12 Port ModLink Cassette, Duplex SC, OM2 50µm Multimode	72
KSJ-00005-0*	Consult Molex	Single Position Blank Module (Bag of 25)	27	MLCDSC120M3L	Consult Molex	12 Port ModLink Cassette, Duplex SC, OM3 50µm Multimode, Low Loss	72
KSJ-00005-0*	Consult Molex	Single Position Blank Module (Bag of 25)	36	MLCDSC120M4L	Consult Molex	12 Port ModLink Cassette, Duplex SC, OM4 50µm Multimode, Low Loss	72
KSJ-00005-0*	Consult Molex	Single Position Blank Module (Bag of 25)	90	MLCDSC120S2L	Consult Molex	12 Port ModLink Cassette, Duplex SC, OS1/2 Singlemode	72
KSJ-00018.**	Consult Molex	PowerCat 6 DataGate Jack 8W 568A/B	25	MLCMTR120M1	Consult Molex	12 Port ModLink Cassette, MT-RJ, OM1 62.5µm Multimode	72
KSJ-00024.**	Consult Molex	PowerCat 5e DataGate Jack 8W 568A/B	35	MLCMTR120M2	Consult Molex	12 Port ModLink Cassette, MT-RJ, OM2 50µm Multimode	72
KSJ-00032.**	Consult Molex	Keystone Jack, Category 5e, 8W, 568A/B	35	MLCMTR120M3L	Consult Molex	12 Port ModLink Cassette, MTRJ, OM3 50µm Multimode, Low Loss	72
KSJ-00033.**	Consult Molex	Keystone Jack, Category 6, 8W, 568A/B	26	MLCMTR120M4L	Consult Molex	12 Port ModLink Cassette, MT-RJ, OM4 50µm Multimode, Low Loss	72
KSJ-00035-02	Consult Molex	PowerCat 10G DataGate Jack RJ45 568A/B Shielded-White shutter	32	MLCDSC120S2L	Consult Molex	12 Port ModLink Cassette, Duplex SC, OS1/2 Singlemode	72
KSJ-00035-04	Consult Molex	PowerCat 10G DataGate Jack RJ45 568A/B Shielded-Black shutter	32	MLCMTR120M1	Consult Molex	12 Port ModLink Cassette, MT-RJ, OM1 62.5µm Multimode	72
KSJ-00062.**	Consult Molex	PowerCat 6A Jack RJ45 568A/B Shielded	16	MLCMTR120M2	Consult Molex	12 Port ModLink Cassette, MT-RJ, OM2 50µm Multimode	72
KSJ-00064.**	Consult Molex	Keystone Blank	37	MLCMTR120M3L	Consult Molex	12 Port ModLink Cassette, MTRJ, OM3 50µm Multimode, Low Loss	72
KSJ-00073.**	Consult Molex	PowerCat 6A Side Entry Jack Shielded	16	MLCMTR120M4L	Consult Molex	12 Port ModLink Cassette, MT-RJ, OM4 50µm Multimode, Low Loss	72
KSJ-00079	Consult Molex	PowerCat 6A Tool-less shielded Keystone Jack, RJ45, 360°, 568A/B	22	MLCDSC120S2L	Consult Molex	12 Port ModLink Cassette, Duplex SC, OS1/2 Singlemode	72
KSJ-00089	180430046	Category 6, G3 UTP MIIM, Keystone Jack - white	11	MLCMTR120M1	Consult Molex	12 Port ModLink Cassette, MT-RJ, OM1 62.5µm Multimode	72
KSJ-00091.**	Consult Molex	Keystone Jack C6A UTP 568A/B	14	MLCMTR120M2	Consult Molex	12 Port ModLink Cassette, MT-RJ, OM2 50µm Multimode	72
KSP-00001	Consult Molex	Category 6A Field Termination Plug	20	MLCMTR120M3L	Consult Molex	12 Port ModLink Cassette, MTRJ, OM3 50µm Multimode, Low Loss	72
MEU-00005-02	184000314	Angled ST Module, Multimode - 4 Adapters	66	MLCMTR120M4L	Consult Molex	12 Port ModLink Cassette, MT-RJ, OM4 50µm Multimode, Low Loss	72
MEU-00005-02	184000314	Angled ST Module, Multimode - 4 Adapters	68	MLCDSC120S2L	Consult Molex	12 Port ModLink Cassette, Duplex SC, OS1/2 Singlemode	72
MEU-00006-02	Consult Molex	Angled ST Module, Singlemode - 4 Adapters	66	MLCQLC120M1	180370268	12 Port ModLink Cassette, Quad LC, OM1 62.5µm Multimode	72
MEU-00006-02	Consult Molex	Angled ST Module, Singlemode - 4 Adapters	68	MLCQLC120M2	180370267	12 Port ModLink Cassette, Quad LC, OM2 50µm Multimode	72
MEU-00007-02	Consult Molex	Angled ST Module, Multimode - 2 Adapters	66	MLCQLC120M3L	Consult Molex	12 Port ModLink Cassette, Quad LC, OM3 50µm Multimode, Low Loss	72
MEU-00007-02	Consult Molex	Angled ST Module, Multimode - 2 Adapters	68	MLCQLC120M4L	Consult Molex	12 Port ModLink Cassette, Quad LC, OM4 50µm Multimode, Low Loss	72
MEU-00009-02	181210016	Angled Shuttered Duplex SC Module, Multimode -2 Adapters	66				
MEU-00009-02	181210016	Angled Shuttered Duplex SC Module, Multimode -2 Adapters	68				
MEU-00010-02	182620000	Angled Shuttered Duplex SC Module, Singlemode -2 Adapters	66				
MEU-00010-02	182620000	Angled Shuttered Duplex SC Module, Singlemode -2 Adapters	68				

Order No. Reference

Order No.	SAP No.	Description	Page	Order No.	SAP No.	Description	Page
MLCQLC120S2L	Consult Molex	12 Port ModLink Cassette, Quad LC, OS1/2 Singlemode	72	PCD-00468-0P	181880029	PowerCat 6 U/UTP Solid Cable Patch Cord Assembly LS0H VL Dca-s2,d2,a1 20m	31
MLCQLC240M1	Consult Molex	24 Port ModLink Cassette, Quad LC, OM1 62.5µm Multimode	72	PCD-00469-0P	181880030	PowerCat 6 U/UTP Solid Cable Patch Cord Assembly LS0H VL Dca-s2,d2,a1 30m	31
MLCQLC240M2	Consult Molex	24 Port ModLink Cassette, Quad LC, OM2 50µm Multimode	72	PCD-00470-0P	181880031	PowerCat 6 U/UTP Solid Cable Patch Cord Assembly LS0H VL Dca-s2,d2,a1 40m	31
MLCQLC240M3L	Consult Molex	24 Port ModLink Cassette, Quad LC, Low Loss, OM3 50µm Multimode	72	PCD-00471-0P	181880032	PowerCat 6 U/UTP Solid Cable Patch Cord Assembly LS0H VL Dca-s2,d2,a1 50m	31
MLCQLC240M4L	Consult Molex	24 Port ModLink Cassette, Quad LC, Low Loss, OM4 50µm Multimode	72	PCD-00472-0P	181880033	PowerCat 6 U/UTP Solid Cable Patch Cord Assembly LS0H VL Dca-s2,d2,a1 60m	31
MLCQLC240S2L	Consult Molex	24 Port ModLink Cassette, Quad LC, Low Loss, OS2 Singlemode	72	PCD-01000-**	Consult Molex	PowerCat 5e U/UTP Patch Cord LS0H - 0.5m	39
MLG-00021-02	188000016	PowerCat 6 22.5 x 45mm Legrand Compatible Module RJ45 568A/B UTP - White	30	PCD-01001-**	Consult Molex	PowerCat 5e U/UTP Patch Cord LS0H - 1m	39
MLG-00022-02	Consult Molex	PowerCat 6 22.5 x 45mm Legrand Compatible Module RJ45 568A/B Shielded - White	33	PCD-01002-**	Consult Molex	PowerCat 5e U/UTP Patch Cord LS0H - 1.5m	39
MLG-00024-02	188000068	PowerCat 6 45 x 45mm Legrand Compatible Module RJ45 568A/B UTP - White	30	PCD-01003-**	Consult Molex	PowerCat 5e U/UTP Patch Cord LS0H - 2m	39
MLG-00025-02	188000069	PowerCat 6 45 x 45mm Legrand Compatible Module RJ45 568A/B Shielded - White	33	PCD-01005-**	Consult Molex	PowerCat 5e U/UTP Patch Cord LS0H - 3m	39
MLG-00030-**	183010006	PowerCat 6A 22.5 x 45mm Legrand compatible Module	23	PCD-01009-**	Consult Molex	PowerCat 5e U/UTP Patch Cord LS0H - 5m	39
MLG-00031-**	183010007	PowerCat 6A 45 x 45mm Legrand compatible Module	23	PCD-01013-**	Consult Molex	PowerCat 5e U/UTP Patch Cord LS0H - 7m	39
MLG-00034-**	Consult Molex	PowerCat 6A 45 x 45mm Side Entry Module RJ45 568A/B	23	PCD-01019-**	Consult Molex	PowerCat 5e U/UTP Patch Cord LS0H - 10m	39
MLG-00035-**	Consult Molex	PowerCat 6A 22.5 x 45mm Side Entry Module RJ45 568A/B	23	PCD-02000-**	Consult Molex	PowerCat 6 U/UTP Patch Cord LS0H - 0.5m	31
MLG-00037-02	181770331	Keystone Jack Fascia, 22.5 x 45mm, unloaded - white	87	PCD-02001-**	Consult Molex	PowerCat 6 U/UTP Patch Cord LS0H - 1m	31
MMC-00010-**	Consult Molex	PowerCat 6 MOD-Clip DataGate Jack 568 A/B	26	PCD-02002-**	Consult Molex	PowerCat 6 U/UTP Patch Cord LS0H - 1.5m	31
MMC-00017-02	183010020	PowerCat 6A MOD-Clip Shielded Jack 8W 568 A/B White	24	PCD-02003-**	Consult Molex	PowerCat 6 U/UTP Patch Cord LS0H - 2m	31
MMC-00017-04	183010019	PowerCat 6A MOD-Clip Shielded Jack 8W 568 A/B Black	24	PCD-02005-**	Consult Molex	PowerCat 6 U/UTP Patch Cord LS0H - 3m	31
MMC-00020-**	Consult Molex	PowerCat 6A Side Entry MOD-Clip DataGate Jack, RJ45, 568A/B Shielded	24	PCD-02009-**	Consult Molex	PowerCat 6 U/UTP Patch Cord LS0H - 5m	31
MMS-00004-**	182160000	MOD-SNAP RJLP Module RJ45 568B FTP Category 5e - White	41	PCD-02013-**	Consult Molex	PowerCat 6 U/UTP Patch Cord LS0H - 7m	31
MMS-00013-**	181780003	PowerCat 6 Angled MOD-SNAP III Module RJ45 568A/B UTP	29	PCD-02019-**	Consult Molex	PowerCat 6 U/UTP Patch Cord LS0H - 10m	31
MMS-00014-**	181170009	MOD-SNAP Module Blank	29	PCD-04001-**	Consult Molex	PowerCat 6 Patch cord, F/UTP, RJ45, 568B, Stranded, LS0H - 1m	34
MMS-00014-**	Consult Molex	MOD-SNAP Module Blank	87	PCD-04003-**	Consult Molex	PowerCat 6 Patch cord, F/UTP, RJ45, 568B, Stranded, LS0H - 2m	34
MMS-00014-0*	181170009	MOD-SNAP Module Blank - White	38	PCD-04005-**	Consult Molex	PowerCat 6 Patch cord, F/UTP, RJ45, 568B, Stranded, LS0H - 3m	34
MMS-00014-02	Consult Molex	MOD-SNAP Blank Module - White	89	PCD-04009-**	Consult Molex	PowerCat 6 Patch cord, F/UTP, RJ45, 568B, Stranded, LS0H - 5m	34
MMS-00017-02	183010003	PowerCat 6A Angled MOD-SNAP III RJ45 Module, 568A/B - White	23	PCD-04013-**	Consult Molex	PowerCat 6 Patch cord, F/UTP, RJ45, 568B, Stranded, LS0H - 7m	34
MMS-00017-04	183010011	PowerCat 6A Angled MOD-SNAP III RJ45 Module, 568A/B - Black	23	PCD-04019-**	Consult Molex	PowerCat 6 Patch cord, F/UTP, RJ45, 568B, Stranded, LS0H - 10m	34
MMS-00019-**	Consult Molex	PowerCat 6A Angled Side Entry MOD-SNAP III Module RJ45 568B, Shielded	23	PCD-06000-0P	181880037	PowerCat 6 U/UTP Solid Cable Patch Cord Assembly LS0H VL Dca-s2,d2,a1 15m	31
MMS-00020-02	1817703302	Mod-Snap Keystone Jack Fascia, 38.5 x 25mm, unloaded - white	88	PCD-06001-0P	181880038	PowerCat 6 U/UTP Solid Cable Patch Cord Assembly LS0H VL Dca-s2,d2,a1 25m	31
MSY-00002-0*	Consult Molex	Single Position F Video Module	90	PCD-060021-0P	181880039	PowerCat 6 U/UTP Solid Cable Patch Cord Assembly LS0H VL Dca-s2,d2,a1 35m	31
MSY-00003-**	Consult Molex	Single ST Module, Singlemode/Multimode	66	PCD-07000-**	Consult Molex	PowerCat 6A Patch Cord 568A/B Shielded, LS0H - 1m	15
MSY-00018-**	Consult Molex	Simplex Shuttered SC Module, Singlemode	67	PCD-07000-**	Consult Molex	PowerCat 6A Patch Cord 568A/B Shielded, LS0H - 1m	18
MSY-00032-0*	Consult Molex	Single Position S Video Coupler Module	90	PCD-07001-**	Consult Molex	PowerCat 6A Patch Cord 568A/B Shielded, LS0H - 2m	15
MSY-00033-R*	Consult Molex	Single Position RCA Coupler Red Module	90	PCD-07001-**	Consult Molex	PowerCat 6A Patch Cord 568A/B Shielded, LS0H - 2m	18
MSY-00033-W*	Consult Molex	Single Position RCA Coupler White Module	90	PCD-07002-**	Consult Molex	PowerCat 6A Patch Cord 568A/B Shielded, LS0H - 3m	15
MSY-00033-Y*	Consult Molex	Single Position RCA Coupler Yellow Module	90	PCD-07002-**	Consult Molex	PowerCat 6A Patch Cord 568A/B Shielded, LS0H - 3m	18
MSY-00036-0*	Consult Molex	Single Position BNC Coupler Module	90	PCD-07004-**	Consult Molex	PowerCat 6A Patch Cord 568A/B Shielded, LS0H - 5m	15
MSY-00040-**	Consult Molex	Single LC Module, Multimode	67	PCD-07004-**	Consult Molex	PowerCat 6A Patch Cord 568A/B Shielded, LS0H - 5m	18
MUS-00096-0*	Consult Molex	1 Port Fascia (Bag of 10) - 25 x 50mm	90	PCD-07006-**	Consult Molex	PowerCat 6A Patch Cord 568A/B Shielded, LS0H - 7m	15
MUS-00097-0*	Consult Molex	2 Port Fascia (Bag of 10) - 25 x 50mm	90	PCD-07006-**	Consult Molex	PowerCat 6A Patch Cord 568A/B Shielded, LS0H - 7m	18
MUS-00185	Consult Molex	Blank Module (Bag of 10) - 25 x 50mm	90	PCD-07009-**	Consult Molex	PowerCat 6A Patch Cord 568A/B Shielded, LS0H - 10m	15
PCD-00456-0E	Consult Molex	PowerCat 6 U/UTP Solid Cable Patch Cord Assembly PVC Eca Grey 4m	31	PCD-07009-**	Consult Molex	PowerCat 6A Patch Cord 568A/B Shielded, LS0H - 10m	18
PCD-00457-0E	Consult Molex	PowerCat 6 U/UTP Solid Cable Patch Cord Assembly PVC Eca Grey - 6m	31	PCD-07054-VL	183160844	PowerCat 6A Shielded Solid Cable Assembly, U/FTP, LS0H, VL Dca-s2,d1,a1 4m	19
PCD-00458-0E	Consult Molex	PowerCat 6 U/UTP Solid Cable Patch Cord Assembly PVC Eca Grey - 8m	31	PCD-07055-VL	183160845	PowerCat 6A Shielded Solid Cable Assembly, U/FTP, LS0H, VL Dca-s2,d1,a1 6m	19
PCD-00459-0E	Consult Molex	PowerCat 6 U/UTP Solid Cable Patch Cord Assembly PVC Eca Grey - 10m	31	PCD-07056-VL	183160846	PowerCat 6A Shielded Solid Cable Assembly, U/FTP, LS0H, VL Dca-s2,d1,a1 8m	19
PCD-00460-0E	Consult Molex	PowerCat 6 U/UTP Solid Cable Patch Cord Assembly PVC Eca Grey - 20m	31	PCD-07057-VL	183160847	PowerCat 6A Shielded Solid Cable Assembly, LS0H, U/FTP, VL Dca-s2,d1,a1 10m	19
PCD-00461-0E	Consult Molex	PowerCat 6 U/UTP Solid Cable Patch Cord Assembly PVC Eca Grey - 30m	31	PCD-07058-VL	183160848	PowerCat 6A Shielded Solid Cable Assembly, LS0H, U/FTP, VL Dca-s2,d1,a1 20m	19
PCD-00462-0E	Consult Molex	PowerCat 6 U/UTP Solid Cable Patch Cord Assembly PVC Eca Grey - 40m	31	PCD-07059-VL	183160849	PowerCat 6A Shielded Solid Cable Assembly, LS0H, U/FTP, VL Dca-s2,d1,a1 30m	19
PCD-00464-0P	181880025	PowerCat 6 U/UTP Solid Cable Patch Cord Assembly LS0H VL Dca-s2,d2,a1 4m	31	PCD-07060-VL	183160850	PowerCat 6A Shielded Solid Cable Assembly, LS0H, U/FTP, VL Dca-s2,d1,a1 40m	19
PCD-00465-0P	181880026	PowerCat 6 U/UTP Solid Cable Patch Cord Assembly LS0H VL Dca-s2,d2,a1 6m	31	PCD-07061-**	Consult Molex	PowerCat 6A Patch Cord 568A/B Shielded, LS0H - 1.5m	15
PCD-00466-0P	181880027	PowerCat 6 U/UTP Solid Cable Patch Cord Assembly LS0H VL Dca-s2,d2,a1 8m	31	PCD-07061-**	Consult Molex	PowerCat 6A Patch Cord 568A/B Shielded, LS0H - 1.5m	18
PCD-00467-0P	181880028	PowerCat 6 U/UTP Solid Cable Patch Cord Assembly LS0H VL Dca-s2,d2,a1 10m	31	PCD-07069-0E	Consult Molex	Locking Patch cord RJ45-RJ45, 568B, F/FTP, Stranded, PowerCat 6A, LS0H 1m Grey	19

Order No. Reference

Order No.	SAP No.	Description	Page	Order No.	SAP No.	Description	Page
PCD-07071-0E	Consult Molex	Locking Patch cord RJ45-RJ45, 568B, F/FTP, Stranded, PowerCat 6A, L50H 2m Grey	19	PID-00261	180810034	PowerCat 48 Port DataGate Angled Patch Panel, Unloaded UTP or Shielded - 2U	36
PCD-07073-0E	Consult Molex	Locking Patch cord RJ45-RJ45, 568B, F/FTP, Stranded, PowerCat 6A, L50H 3m Grey	19	PID-00282	180810045	1U 24 Port, Angled Keystone Jack Aperture, Patch Panel - Unloaded	22
PCD-07077-0E	Consult Molex	Locking Patch cord RJ45-RJ45, 568B, F/FTP, Stranded, PowerCat 6A, L50H 5m Grey	19	PID-00282	180810045	Patch panel 1 U 24 Port. Angled aperture, Keystone Jack, Unloaded	27
PCD-07079-0E	Consult Molex	Locking Patch cord RJ45-RJ45, 568B, F/FTP, Stranded, PowerCat 6A, L50H 7m Grey	19	PID-00283	183200023	1U 24 Port Category 6 UTP MIIM G3 Jack Loaded Patch Panel W/O Control Unit	10
PCD-07082-0E	Consult Molex	Locking Patch cord RJ45-RJ45, 568B, F/FTP, Stranded, PowerCat 6A, L50H 10m Grey	19	PID-00285	183210036	1U 24 Port Category 6A Shielded MIIM G3 Jack Loaded Patch Panel W/O Control Unit	10
PCD-07083	Consult Molex	Pack of 5 Keys for Locking Patch Cords	19	RAA-00002	180310026	Open Bay Rack	82
PCD-08000-OP	183270077	PowerCat 6A Shielded Solid Cable Assembly, L50H, U/FTP, VL Dca-s2,d1,a1 15m	19	RFR-00201	180370259	24-48 Port Specification Grade Fibre Enclosure - 1U	55
PCD-08001-OP	183270078	PowerCat 6A Shielded Solid Cable Assembly, L50H, U/FTP, VL Dca-s2,d1,a1 25m	19	RFR-00202	180370260	48-96 Port Specification Grade Fibre Enclosure - 2U	55
PCD-08002-OP	183270079	PowerCat 6A Shielded Solid Cable Assembly, L50H, U/FTP, VL Dca-s2,d1,a1 35m	19	RFR-00204	180660016	144-288 Port Specification Grade Fibre Enclosure - 4U	55
PCD-08003-OP	183270080	PowerCat 6A Shielded Solid Cable Assembly, L50H, U/FTP, VL Dca-s2,d1,a1 50m	19	RFR-00205	180660017	Swing-Out Fibre Panel Chassis - 1U	55
PCD-08004-OP	183270081	PowerCat 6A Shielded Solid Cable Assembly, L50H, U/FTP, VL Dca-s2,d1,a1 60m	19	RFR-00206	180660018	Swing Out Fibre Panel Front Plate Blank	55
PCPT6ASXXXX	Consult Molex	PowerCat 6A Pre-Terminated Cable Assemblies	21	RFR-00207	180660019	Swing Out Fibre Panel Shuttered Front Plate 6 Duplex SC SM	55
PID-00030	181430008	PowerCat 5e 24 Port Patch Panel with Cover 568A/B Shielded - 1U	40	RFR-00208	180660020	Swing Out Fibre Panel Shuttered Front Plate 6 SC MM	55
PID-00058	181530012	PowerCat 5e 24 Port Patch Panel RJ45 568B UTP - 1U	36	RFR-00209	180660021	Swing Out Fibre Panel Shuttered Front Plate 12 Duplex LC SM	55
PID-00073	181820012	PowerCat 5e 48 Port High Density Patch Panel RJ45 56B UTP - 1U	37	RFR-00210	180660022	Swing Out Fibre Panel Front Plate 12 ST SM/MM	55
PID-00141	182040009	PowerCat 6 24 Port Patch Panel RJ45 568A/B UTP - 1U	26	RFR-00212	180660024	Swing-Out Panel Shuttered Front Plate 12 DLC MM	55
PID-00142	182040010	PowerCat 6 48 Port Patch Panel RJ45 568A/B UTP - 2U	26	RFR-00213	180660025	Swing-Out Panel Unshuttered Front Plate 6 DSC SM	55
PID-00145	182040013	50 Port Voice Panel RJ45 UTP 1U - Pairs 3/6, 4/5	86	RFR-00214	180660026	Swing-Out Panel Unshuttered Front Plate 6 DSC MM	55
PID-00154	182020245	PowerCat 5e 24 Port Angled Patch Panel RJ45 568A/B UTP - 1U	37	RFR-00311-BK	180370287	1U Multi-Function Fibre Enclosure Gen II	51
PID-00155	182080295	PowerCat 5e 48 Port Angled Patch Panel RJ45 568A/B UTP - 2U	37	RFR-00312-BK	180370288	Locking Front Assembly Kit	51
PID-00156	182080297	PowerCat 6 24 Port Angled Patch Panel RJ45 568A/B UTP - 1U	27	RFR-00318	183230013	MIIM G3 48F Duplex LC MM Fibre Patch Panel, W/O control unit	11
PID-00157	182080299	PowerCat 6 48 Port Angled Patch Panel RJ45 568A/B UTP - 2U	27	RFR-00319	183230014	MIIM G3 48F Duplex LC SM Fibre Patch Panel, W/O control unit	11
PID-00174	182080372	PowerCat 5e 24 Port DataGate Patch Panel RJ45 568A/B UTP - 1U	36	SBX-00005-02	181770326	PowerCat 6 1 Port Synergy Surface Box RJ45 568A/B UTP - White	29
PID-00175	182080374	PowerCat 5e 48 Port DataGate Patch Panel RJ45 568A/B UTP - 2U	36	SBX-00006-02	Consult Molex	PowerCat 5e 1 Port Synergy Surface Box RJ45 568A/B UTP - White	38
PID-00182	181520015	PowerCat 6 24 Port Patch Panel 568A/B Shielded - 1U	32	SBX-00009-02	Consult Molex	PowerCat 6A 1 Port Synergy Surface Box RJ45 568A/B Shielded - White (loaded)	24
PID-00217	182960000	PowerCat 6A 24 Port Patch Panel 568A/B Shielded - 1U	17	SSY-00007-02	181770323	PowerCat 6 2 Port Synergy Surface Box RJ45 568A/B UTP - White	29
PID-00218	182960001	PowerCat 6A 24 Port Angled Patch Panel 568A/B Shielded - 1U	17	SSY-00008-02	181770324	PowerCat 6 4 Port Synergy Surface Box RJ45 568A/B UTP - White	29
PID-00219	182960002	PowerCat 6A 48 Port Patch Panel 568A/B Shielded - 2U	17	SSY-00009-02	181770325	PowerCat 6 6 Port Synergy Surface Box RJ45 568A/B UTP - White	29
PID-00220	182960003	PowerCat 6A 48 Port Angled Patch Panel 568A/B Shielded - 2U	17	SSY-00010-02	181770327	PowerCat 5e 2 Port Synergy Surface Box RJ45 568A/B UTP - White	38
PID-00257	182960014	Keystone Jack Panel, 24 port, Unloaded - 1U	22	SSY-00011-02	181770328	PowerCat 5e 4 Port Synergy Surface Box RJ45 568A/B UTP - White	38
PID-00257	182960014	Keystone Jack Panel, 24 port, Unloaded - 1U	28	SSY-00012-02	181770329	PowerCat 5e 6 Port Synergy Surface Box RJ45 568A/B UTP - White	38
PID-00257	182960014	Keystone Patch Panel, 24 Port, Unloaded - 1U	37	SSY-00014-02	181340013	PowerCat 6A 2 Port Synergy Surface Box, Unloaded - White	24
PID-00257	180810023	24 Port Keystone Patch Panel - Unloaded - 1U	14	SSY-00015-02	181340016	PowerCat 6A 4 Port Synergy Surface Box, Unloaded - White	24
PID-00258	180810031	PowerCat 24 Port DataGate Patch Panel, Unloaded UTP or Shielded - 1U	17	SSY-00016-02		PowerCat 6A 6 Port Synergy Surface Box, Unloaded - White	24
PID-00258	180810031	PowerCat 24 Port DataGate Patch Panel, Unloaded UTP or Shielded - 1U	21	WFR-00010-02		6 Port ST 601 Enclosure, Multimode	56
PID-00258	180810031	PowerCat 24 Port DataGate Patch Panel, Unloaded UTP or Shielded - 1U	27	WFR-00011-02	180970010	6 Port ST 601 Enclosure, Singlemode	56
PID-00258	180810031	PowerCat 24 Port DataGate Patch Panel, Unloaded UTP or Shielded - 1U	36	WFR-00015-02	180970011	24 Port MTP 601 Enclosure, Singlemode/Multimode	56
PID-00259	180810032	PowerCat 24 Port DataGate Angled Patch Panel, Unloaded UTP or Shielded - 1U	17	WFR-00016-01	180970023	MMI-Plastic Cover - Almond	56
PID-00259	180810032	PowerCat 24 Port DataGate Angled Patch Panel, Unloaded UTP or Shielded - 1U	21	WFR-00016-01	180970023	MMI-Plastic Cover - Almond	67
PID-00259	180810032	PowerCat 24 Port DataGate Angled Patch Panel, Unloaded UTP or Shielded - 1U	27	WFR-00016-01	180970023	MMI-Plastic Cover - Almond	78
PID-00259	180810032	PowerCat 24 Port DataGate Angled Patch Panel, Unloaded UTP or Shielded - 1U	36	WFR-00016-02	180970024	MMI-Plastic Cover - White	56
PID-00260	180810033	PowerCat 48 Port DataGate Patch Panel, Unloaded UTP or Shielded - 2U	17	WFR-00016-02	180970024	MMI-Plastic Cover - White	67
PID-00260	180810033	PowerCat 48 Port DataGate Patch Panel, Unloaded UTP or Shielded - 2U	21	WFR-00016-02	180970024	MMI-Plastic Cover - White	78
PID-00260	180810033	PowerCat 48 Port DataGate Patch Panel, Unloaded UTP or Shielded - 2U	27	WFR-00016-02	180970024	MMI-Plastic Cover - White	87
PID-00260	180810033	PowerCat 48 Port DataGate Patch Panel, Unloaded UTP or Shielded - 2U	36	WFR-00016-08	180970025	MMI-Plastic Cover - Light Grey	56
PID-00261	180810034	PowerCat 48 Port DataGate Angled Patch Panel, Unloaded UTP or Shielded - 2U	17	WFR-00016-08	180970025	MMI-Plastic Cover - Light Grey	67
PID-00261	180810034	PowerCat 48 Port DataGate Angled Patch Panel, Unloaded UTP or Shielded - 2U	21	WFR-00016-08	180970025	MMI-Plastic Cover - Light Grey	78
PID-00261	180810034	PowerCat 48 Port DataGate Angled Patch Panel, Unloaded UTP or Shielded - 2U	27	WFR-00017	180970021	MMI-R-Metal Cover - Graphite Grey	56
PID-00261	180810034	PowerCat 48 Port DataGate Angled Patch Panel, Unloaded UTP or Shielded - 2U	36	WFR-00017	180970021	MMI-R-Metal Cover - Graphite Grey	67
PID-00261	180810034	PowerCat 48 Port DataGate Angled Patch Panel, Unloaded UTP or Shielded - 2U	45	WFR-00017	180970021	MMI-R-Metal Cover - Graphite Grey	78
PID-00261	180810034	PowerCat 48 Port DataGate Angled Patch Panel, Unloaded UTP or Shielded - 2U	54	WFR-00018	180090008	WM-12 Wall Mounted Steel Enclosure	56
PID-00261	180810034	PowerCat 48 Port DataGate Angled Patch Panel, Unloaded UTP or Shielded - 2U	63	WFR-00018	180090008	WM12 - Graphite Grey	90
PID-00261	180810034	PowerCat 48 Port DataGate Angled Patch Panel, Unloaded UTP or Shielded - 2U	72	WFR-00025-02	180970013	8 Port ST 601 Enclosure, Multimode	56
PID-00261	180810034	PowerCat 48 Port DataGate Angled Patch Panel, Unloaded UTP or Shielded - 2U	81	WFR-00026-02	180970014	8 Port ST 601 Enclosure, Singlemode	56
PID-00261	180810034	PowerCat 48 Port DataGate Angled Patch Panel, Unloaded UTP or Shielded - 2U	90	WFR-00028-02	180970016	8 Port Duplex SC 601 Enclosure, Multimode	56
PID-00261	180810034	PowerCat 48 Port DataGate Angled Patch Panel, Unloaded UTP or Shielded - 2U	99	WFR-00029-02	180970017	8 Port Duplex SC 601 Enclosure, Singlemode	56
PID-00261	180810034	PowerCat 48 Port DataGate Angled Patch Panel, Unloaded UTP or Shielded - 2U	108	WFR-00031-02	180970008	12 Port MT-RJ 601 Enclosure, Singlemode/Multimode	56

Order No. Reference

Order No.	SAP No.	Description	Page
WFR-00034-02	180970073	12 Port LC 601 Enclosure, Multimode	56
WFR-00035-02	180970080	12 Port LC 601 Enclosure, Singlemode	56
WFR-00048	Consult Molex	12 Fibre Multimedia Tamper Proof Enclosure - Red	78
WFR-00048-WH	Consult Molex	12 Fibre Multimedia Tamper Proof Enclosure - White	78
WFR-00054-02	Consult Molex	24 Fibre Multimedia Tamper Proof Enclosure - White	78
WFR-00054-0C	Consult Molex	24 Fibre Multimedia Tamper Proof Enclosure - Red	78
WGB-00001-02	181770083	Contura Single Gang Wallplate (includes grid plate), White - Unloaded	89
WGB-00001-02	181770083	Single Gang wallplate (includes grid plate) - White	88
WGB-00002-02	181770084	Contura Double Gang Wallplate (includes grid plate), White - Unloaded	89
WGB-00002-02	181770084	Double Gang wallplate (includes grid plate) - White	88
WNC-00007-02	182080074	PowerCat 5e 1 Port Fixed Shuttered Wallplate RJ45 568B UTP - White	38
WNC-00008-02	182080046	PowerCat 5e 2 Port Fixed Shuttered Wallplate RJ45 568B UTP - White	38
WNC-00009-02	182080127	PowerCat 5e 4 Port Fixed Shuttered Wallplate RJ45 568B UTP - White	38
WNC-00030-02	180410071	PowerCat 6 1 Port DIN Module RJ45 568A/B UTP - White	30
WNC-00031-02	180410073	PowerCat 6 2 Port DIN Module RJ45 568A/B UTP - White	30
WNC-00036-**	Consult Molex	PowerCat 6 1 Port DIN Module RJ45 568A/B Shielded	33
WNC-00037-**	Consult Molex	PowerCat 6 2 Port DIN Module RJ45 568A/B Shielded	33
WNC-00044-**	Consult Molex	PowerCat 6A 1 Port DIN Module Shielded	24
WNC-00045-**	Consult Molex	PowerCat 6A 2 Port DIN Module Shielded	24
WNC-00050-**	Consult Molex	PowerCat 6A Side Entry DIN Module 1 Port Data-Gate RJ45 568A/B Shielded	24
WNC-00051-**	Consult Molex	PowerCat 6A Side Entry DIN Module 2 Port Data-Gate RJ45 568A/B Shielded	24
WNC-00052-02	181770335	DIN 49075 Keystone Jack Fascia 2 Port with Bezel, unloaded - white	90
XCD-20001	Consult Molex	LC-LC OS1/2 LS0H 1M Long Reach Optical Fibre Patch Cord	54
XCD-20001.5	Consult Molex	LC-LC OS1/2 LS0H 1.5M Long Reach Optical Fibre Patch Cord	54
XCD-20002	Consult Molex	LC-LC OS1/2 LS0H 2M Long Reach Optical Fibre Patch Cord	54
XCD-20003	Consult Molex	LC-LC OS1/2 LS0H 3M Long Reach Optical Fibre Patch Cord	54
XCD-20005	Consult Molex	LC-LC OS1/2 LS0H 5M Long Reach Optical Fibre Patch Cord	54
XCD-20010	Consult Molex	LC-LC OS1/2 LS0H 10M Long Reach Optical Fibre Patch Cord	54
XCD-30001	Consult Molex	LC-LC OM3 LS0H 1M Long Reach Optical Fibre Patch Cord	54
XCD-30001.5	Consult Molex	LC-LC OM3 LS0H 1.5M Long Reach Optical Fibre Patch Cord	54
XCD-30002	Consult Molex	LC-LC OM3 LS0H 2M Long Reach Optical Fibre Patch Cord	54
XCD-30003	Consult Molex	LC-LC OM3 LS0H 3M Long Reach Optical Fibre Patch Cord	54
XCD-30005	Consult Molex	LC-LC OM3 LS0H 5M Long Reach Optical Fibre Patch Cord	54
XCD-30010	Consult Molex	LC-LC OM3 LS0H 10M Long Reach Optical Fibre Patch Cord	54
XCD-40001	Consult Molex	LC-LC OM4 LS0H 1M Long Reach Optical Fibre Patch Cord	54
XCD-40001.5	Consult Molex	LC-LC OM4 LS0H 1.5M Long Reach Optical Fibre Patch Cord	54
XCD-40002	Consult Molex	LC-LC OM4 LS0H 2M Long Reach Optical Fibre Patch Cord	54
XCD-40003	Consult Molex	LC-LC OM4 LS0H 3M Long Reach Optical Fibre Patch Cord	54
XCD-40005	Consult Molex	LC-LC OM4 LS0H 5M Long Reach Optical Fibre Patch Cord	54
XCD-40010	Consult Molex	LC-LC OM4 LS0H 10M Long Reach Optical Fibre Patch Cord	54
XFR-10144	Consult Molex	HD 1 RU Enclosure 12x12F Cassette Capacity MPO/LC 144F	54
XFR-10192	Consult Molex	Xtreme Density 1 RU Enclosure 8x24F Cassette Capacity MPO/LC 192 F	54
XFR-14401	Consult Molex	HD 12F Cassette Capacity MPO/LC OS2 Low Loss	54
XFR-14402	Consult Molex	HD 12F Cassette Capacity MPO/LC OM3 Low Loss	54
XFR-14403	Consult Molex	HD 12F Cassette Capacity MPO/LC OM4 Low Loss	54
XFR-19201	Consult Molex	Xtreme Density 24F Cassette Capacity MPO/LC OS2 Low Loss	54
XFR-19202	Consult Molex	Xtreme Density 24F Cassette Capacity MPO/LC OM3 Low Loss	54
XFR-19203	Consult Molex	Xtreme Density 24F Cassette Capacity MPO/LC OM4 Low Loss	54

Алматы (7273)495-231
Ангарск (3955)60-70-56
Архангельск (8182)63-90-72
Астрахань (8512)99-46-04
Барнаул (3852)73-04-60
Белгород (4722)40-23-64
Благовещенск (4162)22-76-07
Брянск (4832)59-03-52
Владивосток (423)249-28-31
Владикавказ (8672)28-90-48
Владимир (4922)49-43-18
Волгоград (844)278-03-48
Вологда (8172)26-41-59
Воронеж (473)204-51-73
Екатеринбург (343)384-55-89

Иваново (4932)77-34-06
Ижевск (3412)26-03-58
Иркутск (395)279-98-46
Казань (843)206-01-48
Калининград (4012)72-03-81
Калуга (4842)92-23-67
Кемерово (3842)65-04-62
Киров (8332)68-02-04
Коломна (4966)23-41-49
Кострома (4942)77-07-48
Краснодар (861)203-40-90
Красноярск (391)204-63-61
Курск (4712)77-13-04
Курган (3522)50-90-47
Липецк (4742)52-20-81

Россия +7(495)268-04-70

Магнитогорск (3519)55-03-13
Москва (495)268-04-70
Мурманск (8152)59-64-93
Набережные Челны (8552)20-53-41
Нижний Новгород (831)429-08-12
Новокузнецк (3843)20-46-81
Ноябрьск (3496)41-32-12
Новосибирск (383)227-86-73
Омск (3812)21-46-40
Орел (4862)44-53-42
Оренбург (3532)37-68-04
Пенза (8412)22-31-16
Петрозаводск (8142)55-98-37
Псков (8112)59-10-37
Пермь (342)205-81-47

Казахстан +7(7172)727-132

Ростов-на-Дону (863)308-18-15
Рязань (4912)46-61-64
Самара (846)206-03-16
Санкт-Петербург (812)309-46-40
Саратов (845)249-38-78
Севастополь (8692)22-31-93
Саранск (8342)22-96-24
Симферополь (3652)67-13-56
Смоленск (4812)29-41-54
Сочи (862)225-72-31
Ставрополь (8652)20-65-13
Сургут (3462)77-98-35
Сыктывкар (8212)25-95-17
Тамбов (4752)50-40-97
Тверь (4822)63-31-35

Киргизия +996(312)96-26-47

Тольятти (8482)63-91-07
Томск (3822)98-41-53
Тула (4872)33-79-87
Тюмень (3452)66-21-18
Ульяновск (8422)24-23-59
Улан-Удэ (3012)59-97-51
Уфа (347)229-48-12
Хабаровск (4212)92-98-04
Чебоксары (8352)28-53-07
Челябинск (351)202-03-61
Череповец (8202)49-02-64
Чита (3022)38-34-83
Якутск (4112)23-90-97
Ярославль (4852)69-52-93

<https://molex.nt-rt.ru/> || mxd@nt-rt.ru